



Designing Justice+Designing Spaces



Toolkit

Thank you to The Fetzer Institute who generously funded this project.

This project would not have been possible without the support of a massive team of people. We cannot possibly name everyone. We do not even know everyone's name, as many individuals worked silently behind the scenes to facilitate our work. We offer our greatest thanks to all those who actively worked on our behalf in the following institutions and organizations:

State Correctional Institution-Chester (PA)

Philadelphia Prison System/The Cannery (PA)

Carver Correctional Facility for Women (PA)

State Correctional Institution-Graterford (PA)

San Bruno Jail (CA)

Santa Rita Jail (CA)

Community Works and the Resolve to Stop the Violence Project (CA)

Office of Alameda County, County Supervisor Nate Miley (CA)

Haverford College (PA)

Bryn Mawr College (PA)

Eastern Mennonite University/Summer Peacebuilding Institute (VA)

The greatest thank you of all goes out to the incarcerated men and women who enthusiastically and creatively explored the intersection of restorative justice and design under stressful and cramped conditions. We honor their amazing work and this toolkit is dedicated to them.

Photo credits for Peace and Justice Cards (Tool 5)

Robert Fiedler

Samuel Auger

Bryan Rubio

Lorena Thiessen

Michelle Neuber

Copy editing: Deb Gingerich

Art Direction and Design: Mike Nicholls | www.mikenicholls.net

Designing Justice+Designing Spaces, 2015©

Table of Contents

Introduction

• Join Us in Designing Spaces that Restore and Transform!	5
• Purpose and Use of the <i>Designing Justice+Designing Spaces</i> Toolkit	6
• Welcome to Toolkit Users.	7
• Restorative Justice and Design: The Big Picture	9
• About the Tools.	11

Tools

1. Visual Diary	15
2. Collages	33
3. Diagram	55
4. Perspective and Montage	79
5. Peace and Justice Cards	109
6. Model Making with Blocks	181
7. Model Making with Paper	199
8. Checklists and Assessments	221
9. Photo Analysis	249
10. Interviews	261

Appendices

1. Select Resources.	279
2. Preparing to Enter a Correctional Facility.	281
3. Sample Design Supplies	283
4. Recruiting Participants.	285
5. Final Design Concepts	287
6. Reviewing and Presenting Projects	293
7. Sample Workshop Agendas	295



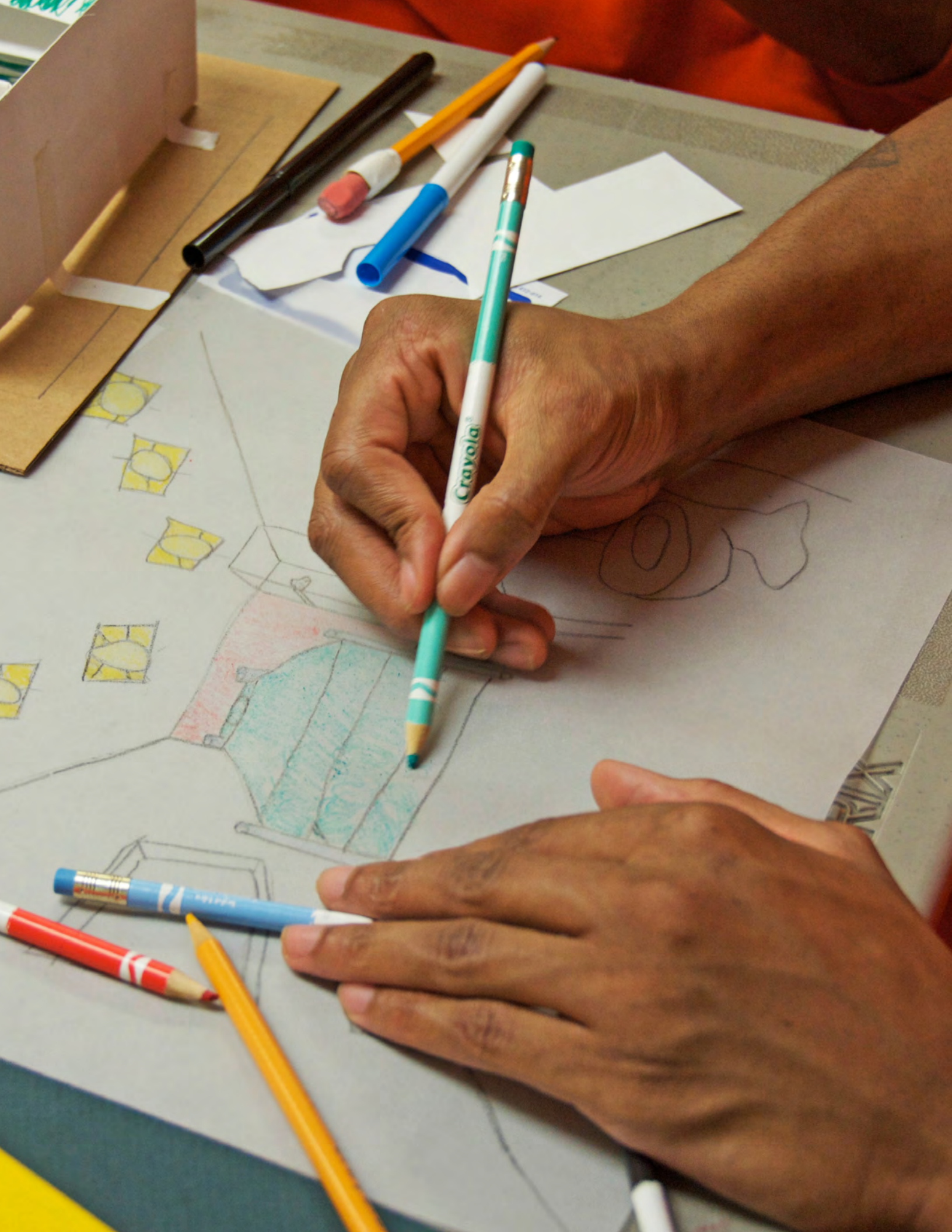



Thank You for Joining Us in Designing Spaces that Restore and Transform!

The *Designing Justice+Designing Spaces (DJ+DS)* project and this toolkit were inspired by questions related to whether and how the architecture and design of justice spaces, such as courthouses and correctional facilities, perpetuated the punitive orientation of the current justice system. We wondered whether there was a way to design justice spaces so that they support a more restorative approach and goals oriented toward accountability, transformation, love, and forgiveness, if desired by those harmed by crime. What would justice buildings look like if restorative justice was the goal?

The *DJ+DS* project brings together a designer and restorative justice practitioner to explore how restorative justice values impact the design of carceral spaces through a multimedia curriculum that combines restorative justice theory and design work. Project activities invite incarcerated individuals and other justice stakeholders to engage in reading and discussions, environmental analyses, experiential activities, and mini-design labs, where they explore the intersection of design and restorative justice.



This toolkit summarizes the tools and learnings from two years of facilitating a variety of processes designed to engage participants in thinking about restorative justice and design. These processes have ranged from twelve-hour workshops, semester-long college classes, and two- to three-hour sessions. Participants have included incarcerated individuals; undergraduate and graduate students of the social sciences, design, and architecture; community members; and criminal justice professionals. We have developed the toolkit for use in all types of educational processes and with a variety of participants and stakeholders. It offers design tools and practices for re-envisioning and designing justice and correctional spaces, tips and suggestions for selecting and using the tools for a variety of settings, and resources related to restorative justice and design theory.

The creation of the toolkit, and the *DJ+DS* project as a whole, has been graciously funded by The Fetzer Institute. The processes we facilitated and learned from throughout the toolkit creation which shaped its final form would not have been possible without the support of many organizations, including Haverford College, Pennsylvania Department of Corrections (especially State Correctional Institutions at Chester and Graterford), Philadelphia Prison System (especially the Cannery), Eastern Mennonite University and the Summer Peacebuilding Institute, Community Works (especially the Resolve to Stop the Violence Project), San Bruno Jail, and Santa Rita Jail.



Purpose and Use of the *DJ+DS* Toolkit

This toolkit has been created to provide techniques and processes for a variety of justice stakeholders and educators so that they can explore architecture and design as it relates to criminal justice, restorative justice, and concepts such as accountability, healing, respect, love, and forgiveness. This exploration includes consideration of the benefits and consequences of personal, interpersonal, and social experiences related to the design of spaces. Our hope is that the use of these tools also inspires discussion of complex social issues, even outside the framework of space and design.

The techniques in this toolkit can be used in a variety of ways—throughout a semester-long course, in short workshops (e.g., one to eighteen hours), or during a one-time exercise in a class. Participants may be invited to select and discuss images or create design concepts for a building or campus of buildings. We offer a variety of sample exercises, activity modifications, and a sample agenda to assist you in customizing the activities for your purposes.



As its creators, we approach the project from different backgrounds and perspectives—architect/designer and restorative justice practitioner/educator. Though we share a vision for justice spaces grounded in restorative justice and enjoy collaboration, we have learned that we speak different languages, use the tools differently, and view participants' designs differently. This has made the work all the more exciting and inspirational. We have attempted to create a toolkit that respects and speaks to the diverse audiences who may use it. As a result, it does not read or look like a typical architectural toolkit, nor a social science technical manual. This diversity is not limited to professional background; it also includes experience living or working in correctional facilities, knowledge of justice theories, experience with victimization, or social demographics such as race, gender, and class. We hope that the toolkit will be useful to incarcerated and non-incarcerated people alike. We have confidence that the designs tools here speak to the diverse world we live in and can inspire conversations that explore issues of marginalization, violence, and social injustice.

Enjoy!



Welcome to Toolkit Users

Welcome to architects and designers from Deanna

As design professionals you are at a distinct advantage in using this toolkit from a technical point of view. The materials and techniques are familiar to most of us and can be elaborated on as you see fit. All content can be used to address the specific project on which you are working. The challenge will be to modify your professional language to access a wide range of education levels and experiences to help participants understand the design skills you are trying to use. You will also need to gain knowledge of restorative justice and the values it presents as opposed to the current criminal justice system with which you may be familiar. This is an essential first step in understanding the foundations for this toolkit. Be sure to read the following section that offers an introduction to the restorative justice philosophy and explores its connection to the design and architecture of justice buildings.

Welcome to those who are not architects and designers from Barb

You are likely a diverse group of people reading this section—social workers, restorative justice practitioners, incarcerated men and women, people who have been victims of crime and violence, criminal justice professionals, victim or offender advocates, or educators of criminal and social justice. You are at a distinct advantage in using this toolkit from a theoretical and process point of view. You may be very familiar with restorative justice. You may have first-hand experience with the criminal justice system, either personally or professionally. You may work every day to minimize social injustice. You may be comfortable leading discussions on difficult topics. The challenge will likely be learning about the field of design and architecture and its practices.

Be sure to read the following section of this toolkit as it offers an important introduction to design and architecture, and links it to restorative justice. You will also likely be new to the design techniques themselves and may not have the confidence to teach them to other people. Some are easier (e.g., collage and design cards) while others may be more challenging (e.g., perspective drawing and model making). The techniques in the toolkit are adaptable for a variety of situations and can be selected based on comfort with a particular technique. That said, challenge yourself to stretch out of your own comfort zone and make an attempt with each tool, no matter how imperfect. Practice, practice, practice! Remember, too, that you and the participants are creating design concepts, not actually constructing buildings in real life. Leave that and the technicalities to architects.

Welcome to those who have never lived or worked in correctional facilities

This toolkit has been created with incarcerated men and women in mind and our intention is to offer tools that can be used in design labs in correctional facilities. Work in a high secure setting such as prisons and jails brings with it a particular set of security concerns, rules and restrictions, and boundaries. You are encouraged, if not expected, to work closely with facility administration and/or community partners who work within the facility. While we provide some preliminary considerations in the appendices, each system is different and successful work requires a good understanding of the local policies and procedures.

Working within correctional environments requires being very present and mindful and listening to both staff and incarcerated men and women. They are ultimately the experts of their lives and incarceration. We, as outsiders, are just applying the tools of our diverse professions to solicit their innate knowledge about spaces that facilitate restoration, accountability, and well-being. Your greatest contribution is to actively listen and observe in order to gain a deeper understanding of your participants' experiences and how you can create spaces that foster restorative and transformative outcomes.



Emily

Anna

Isabella

Emma

Haley

Anna

Anna

Anna

Anna

Anna

Anna



Restorative Justice and Design: The Big Picture

The big picture: Restorative justice

Restorative justice is a philosophical approach to justice that is a departure from the criminal justice system as we typically define and approach it. In short, restorative justice is a way to do justice that actively includes the people impacted by crime – victims, offenders, their families, and communities. Its goal is to do justice in a way that respects and restores each as individuals, repairs relationships, and contributes to the common good (Toews, 2006).

This approach to justice aims to achieve these goals by asking questions and relying on values different from those of the current criminal justice system. Howard Zehr, often considered the grandfather of restorative justice, suggests that the current justice system focuses on the following three central questions (Zehr, 2002):

1. What law was broken?
2. Who is guilty?
3. What do they deserve?

The answer to this final question typically entails a sanction or punishment. On the surface, this may seem fine and appropriate. Unfortunately, these questions rarely, if ever, pertain to the victim, the person who experienced the harm and damages. As a result, their needs are often sidelined, and offenders are rarely held directly accountable for the harms they inflicted.

Zehr suggests that restorative justice asks a new set of questions:

1. Who has been hurt?
2. What are their needs?
3. Who is responsible to attend to those needs?

Punishment no longer serves as the sign of a successful justice outcome; reparations and restoration are the ultimate goals. The process associated with answering these questions is supported by a set of values that focus on respect, accountability, and transformation. Achieving this goal requires an understanding of the unique harms of the crime and the resulting needs of the victim, in terms of reparations. As such, victims are active participants in the justice process, as are offenders as they learn about the impact of their actions and take steps to repair the damage.

A new philosophical approach to justice requires a new set of practices. There exists a diversity of practices shaped by the philosophical questions and values. The most common form of restorative justice practice is victim offender dialogue in its many forms. In this practice, the victim and the offender meet with the assistance of facilitator(s) to discuss what happened and the impact of the crime. When appropriate, victims and offenders may also make agreements in which the offending individual commits to pay for damages or participate in activ-



Beyond Conviction, Tied to the Tracks Film



ities as a form of symbolic restitution. In some models, the dialogue includes participants' communities of care as well as community members. These types of dialogue occur worldwide in juvenile and adult crimes as well as violent and nonviolent crimes. Recent research suggests that these processes are beneficial for victims in terms of lowered trauma symptoms and useful for offenders in terms of increased victim empathy and reduced reoffending.

These processes require new types of room set ups, different from courtrooms. People often sit in circles so that everyone can see each other. The circle configuration also communicates restorative justice values, such as equality and respect for everyone in the room. Rooms need to be flexible so as to accommodate small and large groups, based on victim and offender needs. For many restorative justice practitioners, preparing for a dialogue includes finding the right room and seating arrangement to support people in achieving their goals. In doing so, they begin to translate restorative justice goals and values into a spatial design. They create "restorative space," or space that has been informed by the restorative justice philosophy.



The big picture: Design

The professional practices of architecture, urban design, and planning create spaces that reflect the values of society. This built environment forms the "containers" for nearly all the activities of our lives, and through evidence-based design research, we are learning that these containers have a profound impact on how we feel and behave. Depending on the values we use to design our environments, we can either harm or heal. For example, our current system of criminal justice is both adversarial and punitive so those values are inherent in its materials, forms, and layout.

As one begins to understand the processes and outcomes of restorative justice, it becomes obvious that the values and sensitive nature of the proceedings are so different from that of our current judicial system that the current buildings and spaces are neither relevant nor appropriate. The physical manifestation of restorative justice values requires new types of buildings and spaces.

So how do we begin to develop new spaces for a justice that repairs, instead of punishes? We can begin by exploring a new design process that embodies the values of restorative justice. It is one that deeply engages those who are most impacted by the justice spaces we currently have including those who live in, work at, and experience our jails, prisons detention centers, and courthouses on a regular basis.

The design process itself has the power to give voice to experiences that cannot be verbally expressed, allowing for communication that does not require words or literacy. Additionally it invites participants to reflect critically on their current environment and imagine possibilities for other environments that foster resilience and well-being, positioning the individual as the "expert" of his or her environmental needs. The *Designing Justice+Designing Spaces* project provides us with the tools and framework to do so. Through this more engaged and thoughtful design of current and future restorative justice spaces, we can increase the capacity of restorative justice to heal our communities as they will be occupying spaces that nourish them rather than become symbols of the law.



About the Tools

This toolkit includes ten different tools that you can use to successfully explore the development of new types of justice spaces that are rooted in the values of restorative practices and philosophies. These tools empower stakeholders to take the lead in this exploration and also serve as a way to collect data for the design of real spaces. You can use the tools progressively or individually, based on your comfort level and desired outcomes.

Each toolkit section is divided into the following three sections:

1-Description

The Description section briefly describes the tool, provides an example of the end product, and offers a sample exercise with which you can start using the tool.



2-Plan and Process

The Plan and Process section suggests ways to use the tool, modifications of the sample exercise, and queries for debriefing the exercise to get the most out of the work being produced. As such, this section includes prompts and questions to help you inspire and elicit dialogue and creative expression from participants around restorative justice and design. It is intended to draw out themes of restoration, love, and forgiveness in both the process and the product.



This is a helpful section for all users but may be the most critical for architects who are often not familiar with restorative justice principles or this method of research and client engagement.

3-Make and Build

The Make and Build section includes specific details on the materials and processes required to use the tool, with special consideration for the unique supplies needed when working in a high security institution. It also includes templates and handouts you can use during design processes, which can be modified to suit your needs. Restorative justice practitioners, social workers, or anyone outside of the design professions will find this section most helpful as these tools of visual representation may be more unfamiliar to them.





Ashley

LIGHTS PLAY!!

Tools



Tool 1



Visual Diary

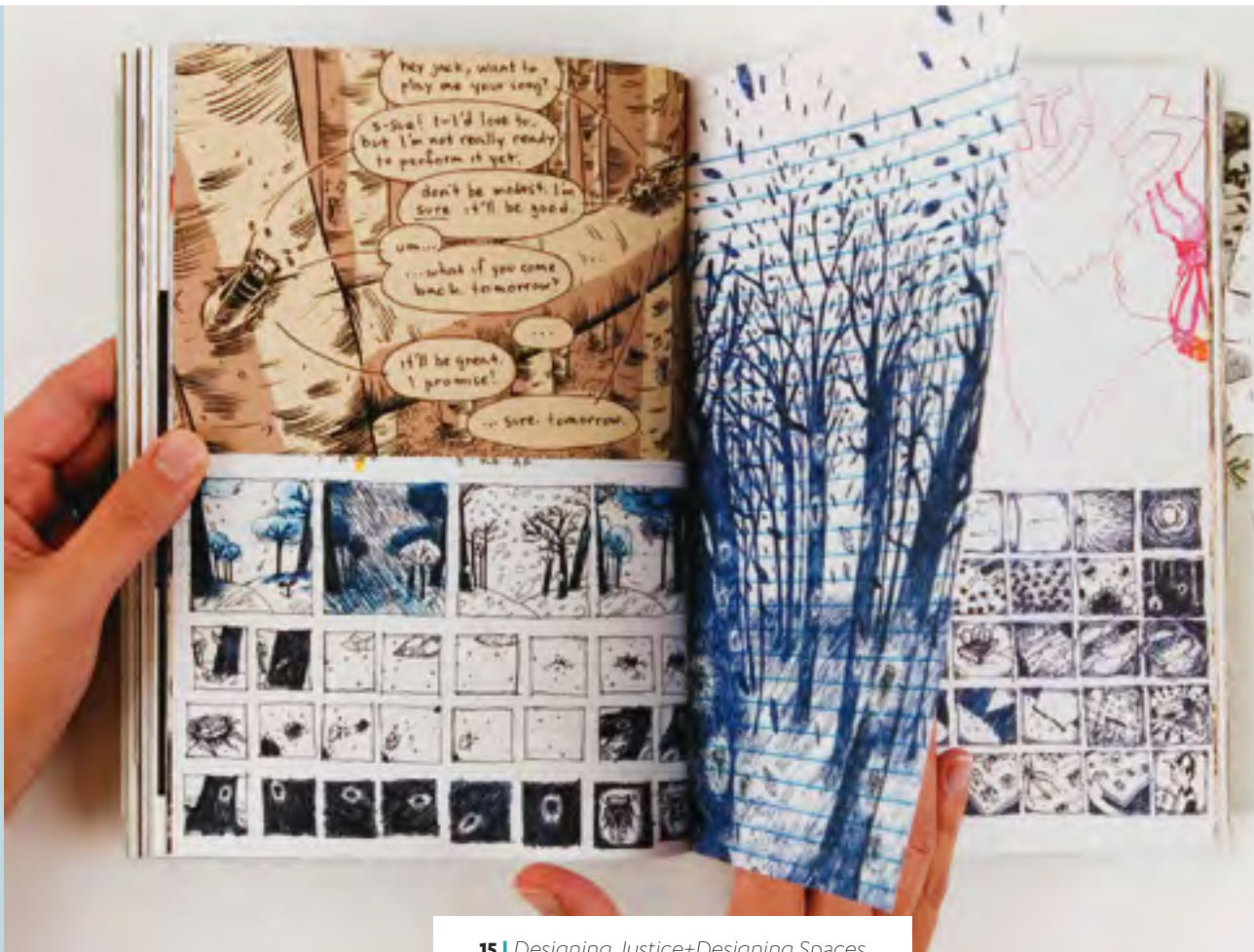



Description

Visual Diary

As we become aware of the world around us, we may find that words no longer give voice to our perspectives. It may become necessary to record thoughts and perceptions in ways that move beyond words. Architects, scientists, designers, and artists often use visual diaries to record their thoughts in real time through sketches, pictures, and found objects. Even those in the social sciences and social work find a journal helpful to record their observations, experiences, and emotions as they go about their work. Like a kind of narrated scrapbook, the visual diary (or journal) provides an analogue tool to communicate to others and ourselves how we perceive and think about the world around us, both verbally and visually.

When used in a learning environment, it also provides a record of what we see for later reflection or analysis (e.g., for a design project or for use at home). The visual images and text become a way of learning and knowing and thus serve as a vital academic resource for considering architecture and environmental design. Participants may respond to prompts provided by the facilitator while gathered for a session or outside of the session. Either way, participants regularly share their diary insights with the rest of the group. In doing so, students contribute their personal experiences and knowledge about design and learn from each other. Students can also affirm each other's creativity and unique contributions to the session, and feel encouraged to continue keeping the journal. Each of these benefits is integral to academic, professional, and personal learnings.

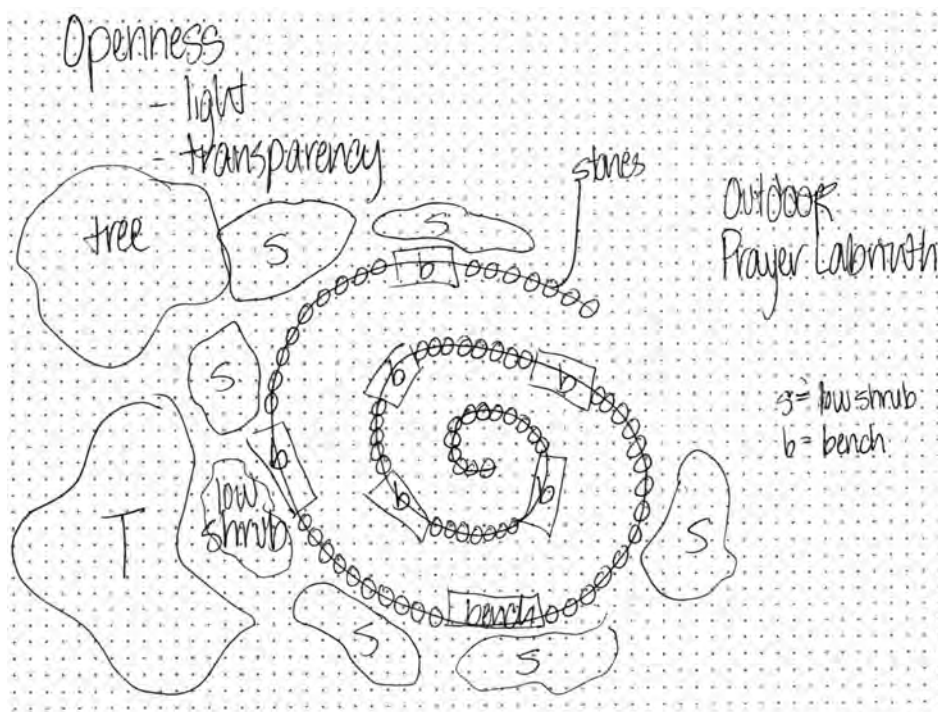

SAMPLE EXERCISE

Invite participants to consider ways in which architecture and design may or may not express love, using the cartoon by Matt Groening included with the Visual Diary handout. In this cartoon, Bongo (the child in the chair) must have done something wrong to be punished by being tied up in the chair. Looking through the door is Binky (his dad) and Sheba (Binky's girlfriend). The heart hanging from the ceiling is meant to suggest that this is a room of love and that it will facilitate some kind of behavior change.



4

The Big Book of Hell, Matt Groening, 1990, Pantheon Books

Give participants a moment to look at the cartoon and talk and laugh with each other. Facilitate a large group discussion, using questions such as the following:

1. How does Bongo appear to be reacting to his experience in this room?
2. Can punishment and love co-exist? Why or why not?
3. Do we have to choose between punishment and love? Why or why not?
4. Can one respond with just love after harmful behavior? Why or why not?
5. What about the design of the room speaks to punishment, and even incarceration?
6. What about the design of the room speaks to love?

Especially in correctional facilities, many participants will immediately begin making the connections between the cartoon and their experience of incarceration. After some discussion of the linkages, be sure to shift the discussion to the design of the space in the cartoon.

Invite the participants to continue considering this cartoon in their visual diary by responding to the following prompt:

If this room was to communicate “love,” what would it look like?

Participants may choose to sketch on the actual cartoon, in addition to entries directly in the diary.



Plan and Process

Use this tool to

- Reflect between sessions.
- Facilitate reflection and design during sessions.
- Plan for individual and group design projects.
- Create space to visualize complex social dynamics.
- Encourage participation from those who may be less confident in their verbal communication skills.
- Engage students who may not feel confident in their writing skills.
- Facilitate learning on topics other than restorative justice.



Modify the sample exercise

Below are examples of prompts that can be provided to students to guide their reflections in their visual diaries. These are in addition to other entries students may choose to make on their own, as well as open journaling related to group projects.

Prompt 1: Reflecting on spaces in our classroom and in our daily lives

1. Reflect back on the room in which the session took place:
 - a. What caught your attention about the room and why?
 - b. How did you react to being in the room and what contributed to those reactions?
 - c. What messages does the room communicate about its occupants?
 - d. What in/of this room facilitates learning, community building, and other goals you hope to achieve in this course?
 - e. If you could change one thing in the room, what would you change and why?
2. As you go about your week, begin to pay attention to the physical and psychological spaces in which you live, work, and play. Consider similar questions to the ones above, comparing and contrasting different spaces, messages, goals, reactions, and modifications. Write a minimum of three entries exploring three different spaces.

Prompt 2: Visualizing restorative justice values

Identify three values associated with restorative justice that are important to you and write an entry on each value, exploring questions such as:

- a. What does this value mean to you and why is it important for justice?
- b. What does this value look like spatially (e.g., room layout, color, objects, etc.)?
- c. Where, if at all, do you experience this value in your current setting, and what is it about the space that represents this value?
- d. Where, if at all, have you experienced this value in another setting, and what did it look like spatially there?



Prompt 3: Designing for justice stakeholders

1. Consider the three major stakeholders of restorative justice practices – victims, offenders, and community members. Identify an experience or restorative goal for each and imagine a dialogue room design that would support this experience or goal. Write and draw an entry for each stakeholder:
 - a. What would the room look, feel, smell, and sound like?
 - b. Have you ever had this experience yourself, and what space/design do you associate with it?
 - c. If you wanted to create this experience for yourself now, what would the associated space be like? How does it compare to the dialogue room you imagined?
2. After writing the three stakeholder entries, imagine a dialogue room design that incorporates as many of the elements of rooms you designed in question 1. Write and draw this room, considering goals and design features that complement and/or contradict each other.



Prompt 4: Reflecting on collages

Reflect on the collage that you created in class today:

- a. What stands out as the overarching concerns and/or features of spaces designed to facilitate a restorative approach and outcomes?
- b. Consider the stakeholder for whom you created the collage (offender, victim, or community):
 - a. What of the symbolic or literal design characteristics of the collage that meet the stakeholders' needs and how?
 - b. How might your collage and its design characteristics be similar to or different from those of the other stakeholders?
- c. Using the symbolic and literal design characteristics in the collage, design a room and/or building that would make restorative justice possible.
- d. Personal reflection:
 - a. What of the restorative justice collage is meaningful to you personally, given your life and experiences?
 - b. Create and/or describe a collage/image of a space that is or would be "restorative" for you.

See Tool #2
for collage
information

Prompt 5: Reflecting on spaces of relaxation

Reflect on the types of spaces in which you can take a break and unwind from everything you have going on in your life. Write/design a few entries about these spaces.



Prompt 6: Reflecting on privacy and “restorative space”

Consider your need for privacy and personal space and reflect on the following questions:

- a. To what degree do you have control over your environment and your experiences in it?
- b. Thinking about the spaces of and strategies you use to create privacy and personal space in your life:
 - a. What does the space/strategy look like?
 - b. What purpose does it serve?
- c. Identify one or two needs you have in your life (psychological, emotional, spiritual, relational, etc.) and design your dream space for meeting that need.

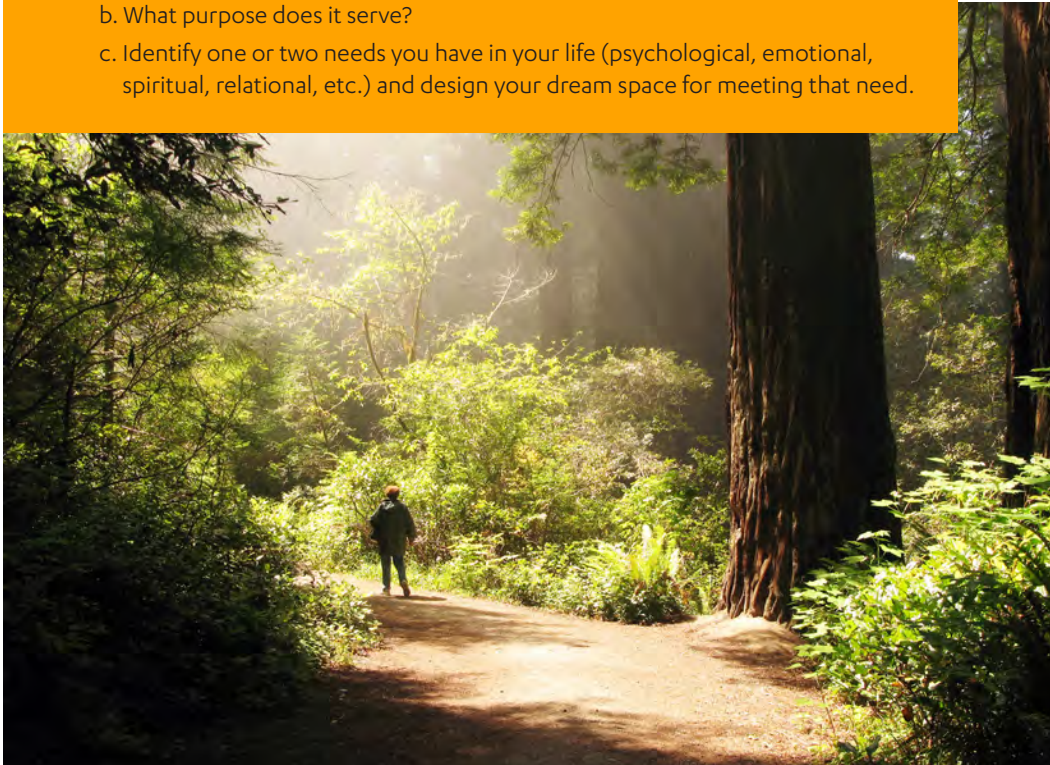

Prompt 7: Restorative justice, social justice, and design

1. Consider the different buildings and spaces in which justice occurs:
 - a. What spaces perpetuate or send messages about racism, oppression, power imbalances, and other social inequalities and discrimination (e.g., socioeconomic status, gender, sexual orientation, disability)?
 - b. What is it about these spaces that contribute to these messages and experiences?
 - c. If you could change these spaces to communicate equality and freedom, what changes would you make?
2. Consider the spaces in which you live, work, and play in every day and reflect on the same questions as above.

Present and debrief the design tool

Invite participants to share their diary entries with the other participants. Some questions to explore include:

- What similarities exist across entries?
- What differences exist across entries?
- What are we learning about the design of spaces through your entries?





Make and Build

Each participant's visual diary will be uniquely his or her own. The facilitator's main role is to provide participants with the basic materials needed to create the diary and to guide their reflection process toward session goals.

Materials

- Pen or pencil.
- Images from magazines or photos that you have taken (printed on regular paper).
- Adhesives such as glue sticks or double-sided tape.
- Diary notebook: Selecting a notebook that is appropriate for the visual diary requires careful consideration, particularly if you are working in a high security setting. Three central considerations are:
 - Glue or fabric binding is preferred as spiral bound notebooks may not be allowed inside the correctional facility, due to security concerns.
 - Notebooks that are 8.5" x 11" or A4 in size provide ample space for the inclusion of images and found objects as well as sketching and writing.
 - Notebooks with a dot grid composition on the pages are preferred over ones with lined or blank pages. Lined notebooks are structured mainly for writing. Blank pages are adequate but a dot grid composition allows for writing, perspective, drawing, and collage. Several companies that make dot grid notebooks of various bindings, sizes, and styles are below. These notebooks are available online from major online book and art supply sellers. For example:
 - Dot Grid Composition Book, created by LayFlat Sketchbooks/Joe Dolan.
 - Fabriano Eco Qua Glued Notebooks, Designer Dot Paper.
 - Rhodia dotpad.
- Found objects: Participants may also wish to include found objects in their journal entries. These are objects that they find on their own as they go about their daily lives and may be, for instance, flyers, flower petals, gum wrappers, bits of cloth, etc.



A word about adhesives in high security settings

Most of us are familiar with writing in notebooks and adding images or found objects with a glue stick or double-sided tape and find it easy to understand and do. However, adhesives like glue or double-sided tape may not be allowed in a high security setting. In this case, participants can add photos by tearing small holes in four locations on a single sheet of the notebook, positioned to create a square. The corners of the image are then inserted into the slots. To create the slots, fold the notebook paper at the point you want to place an edge of the photo and make a small tear. Then, estimate where the other three tears are needed according to the size and shape of your image; the image can serve as the marker for the other tears. In the end, these tears are an effective way to hold images in place and can look beautiful.



Tool
1



Visual Diary

Participant Handout

Visual Diary

As we become aware of the world around us, we may find that words no longer give voice to our perspectives. It may become necessary to record thoughts and perceptions in ways that move beyond words. Architects, scientists, designers, and artists often use visual diaries to record their thoughts in real time through sketches, pictures, and found objects.

Like a kind of narrated scrapbook, the visual diary provides an analogue tool to communicate to others and ourselves about how we perceive and think about the world around us, both verbally and visually. It also provides a record of what we see for later reflection or analysis (e.g., for a design project or for use at home). The visual images and text become a way of learning and knowing and thus serve as a vital resource for considering architecture and environmental design.

The visual diary invites you to reflect on the personal, interpersonal, and social impact of architecture and environmental design and imagine possibilities for an architecture and design that facilitates restorative justice.

Visual diary activity

Consider the cartoon, in which Bongo is tied in the chair, and Binky, his dad, and Sheba, his dad's girlfriend, look through the window and comment. Consider your reaction to this cartoon and what it suggests about spaces in which punishment and love occurs. In your visual diary, reflect on the following question:

If this room was to communicate love, what would it look like?

You may choose to sketch on the actual cartoon, in addition to what you write in the diary.

LIFE IN
HELL

©1988 BY
MATT
GROENING

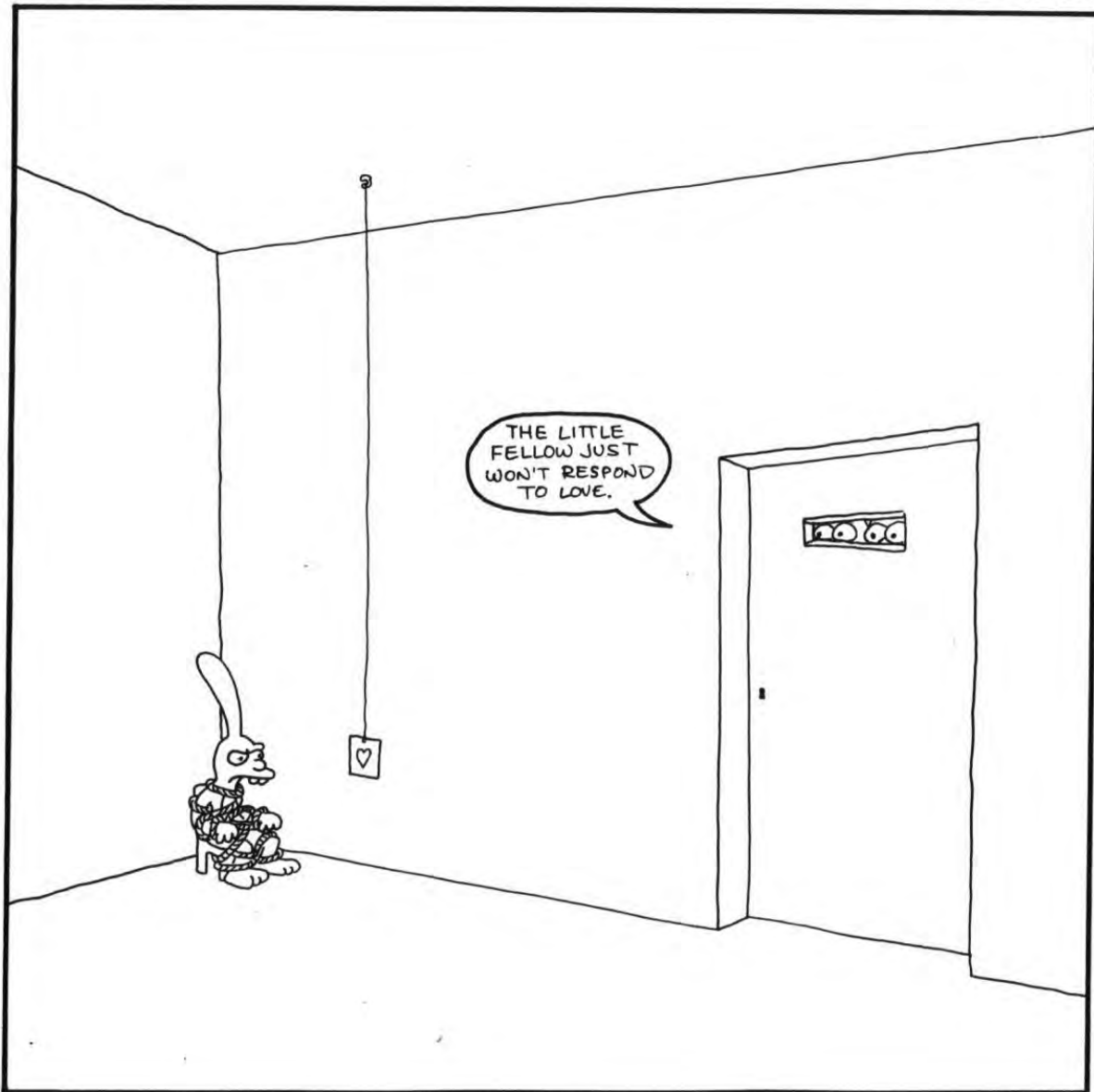

4

The Big Book of Hell, Matt Groening, 1990, Pantheon Books

Tool 2



Collages

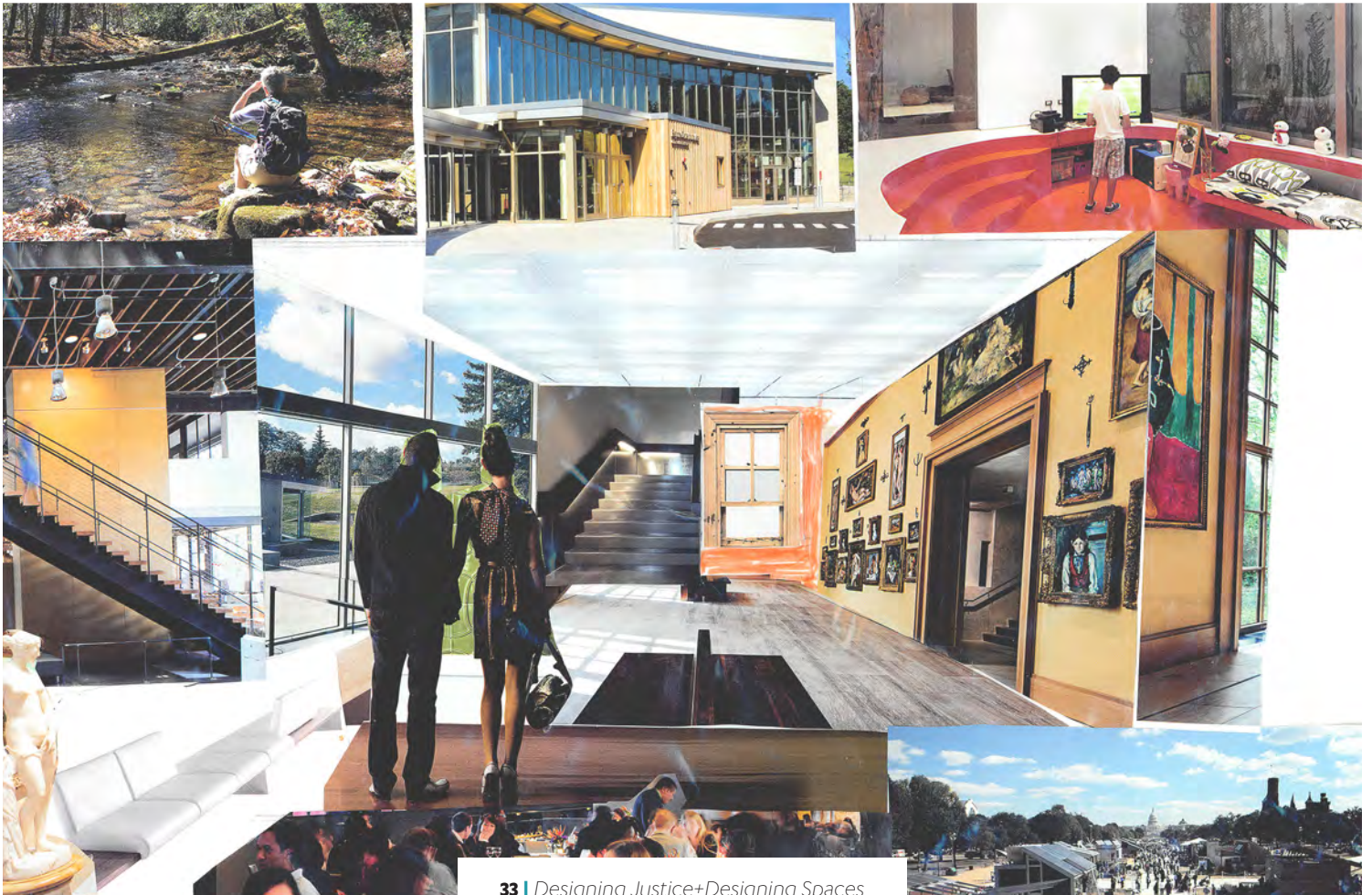



Description

Collage

Collage – pulling together a collection of images and organizing them in a single composition – is an easy way to explore concrete design ideas for a space or explore feelings such as love and forgiveness and how they relate to the design of justice spaces. Images seen in relationship to one another can take on new associations and more complex meanings than they do just on their own. Collage is useful when we do not feel comfortable drawing or sketching, and the use of photographic imagery can be helpful in conveying more complex emotions, intentions, systems, and ideas. In the case of restorative justice, collage is also a helpful tool for representing spaces that may draw on our past experiences and our visions for a new one.



Participants share and discuss their collages with the rest of the group. The facilitator and other participants discuss and critique the collages to explore their discoveries in terms of commonalities, differences, and other themes within and across participants' work. Emphasis should be on helping participants to discover their own interests and creativity and to help them clarify their thoughts, as the collage illustrates participants' understanding and perceptions of issues and helps them to express complex spatial issues.

Give participants the following prompt:

Reflect on the current criminal justice system as well as a criminal justice system that would be based on love. Select one or two images that represent the design of each of these justice approaches.

Allow participants approximately fifteen minutes to select their images from magazines or other images provided. While they are selecting their images, post to the wall a blank piece of paper (large enough to hold all the images) and divide it in half with a line or crease. On one side, participants will glue/tape their images of the current criminal justice system and on the other, their images for a justice system grounded in love.

After participants have selected their images, one-by-one they show and explain their images to the group and paste/tape the images on the appropriate side of the paper. In the course of their sharing, participants will create a group collage that represents all their images and perspectives.

After everyone has shared, facilitate a large group discussion about what can be gleaned from the collage:

1. What do you notice about each side of the collage, in terms of its design features?
2. Looking at each side of the collage separately, what are common design elements?
3. How are the two sides similar? Different?
4. What elements, if any, from the “love” justice are available in our current system?
5. How might justice outcomes differ across the two types of justice? What might contribute to these differences?
6. How might justice outcomes be similar across the two types of justice? What might contribute to these similarities?

If used at the beginning of a design workshop or course, the facilitator can use the collage to introduce the themes, goals, and tools to be used in their time together.



Plan and Process

Use this tool to

- Identify literal and metaphorical characteristics of buildings, rooms, and spaces.
- Picture the “feel” of a place or space.
- Analyze existing spaces and envision new spaces.
- Visualize concepts, ideas, or personal experiences.
- Explore participants understanding and perceptions of themes being discussed.
- Assist students to verbalize complex spatial issues by explaining their collages.
- Build community.
- Build empathy.
- Explore a variety of topics in which visual imagery may facilitate learning.
- Encourage participation from those who may be less confident in their verbal communication skills.



Modify the sample exercise

Prompt 1: Imagine you have to do one of the following:

- Face someone with whom you have had a great deal of conflict.
 - Deal with the worst thing you have ever done in your life.
 - Deal with the worst thing that you have ever experienced in your life.
- What kind of space would you need to do that?

Prompt 2: Create a collage that evokes a space:

- That represents love and self-forgiveness.
- That is restorative and peaceful.
- In which a victim offender dialogue could take place.





Make and Build

The process of making a collage is easy and can be sloppy or neat. As long as you have some adhesive and materials to add to the collage, you are ready to go. Here are some specifics on the materials and suggestions on how to use them.



Materials

- Pictures
 - Magazines, related to such topics as architecture (e.g., Architect, Architecture Record, Dwell), art and photography, lifestyle, travel, culture, and nature, like National Geographic.
 - Precut images, especially if you cannot bring magazines into the institution. Precut images can sometimes make the image selection process faster and easier, if time is limited.
 - Photographs you have taken. Print them out on paper, so they are easier to work with and do not resemble photographs, which may not be permitted inside the institution.
 - Note: Ensure that the images represent a variety of socio-economic, gender, race, and cultural demographics, especially those of the people with whom you are working.

- Papers: Various types of two-dimensional media: Vellum (a type of paper), found objects (e.g., tickets or gum wrappers), construction paper, and patterned papers.
- Pens, markers, pencils and/or paint.
- Adhesives (glue sticks and/or double-sided tape).
- Child's scissors or rulers: Sometimes, children's blunt edge scissors will be allowed into a high security setting, which is ideal. If used, it is essential that you keep track of them as these are still considered dangerous to those who live and work in the facility and must be counted in and out. If children's blunt edge scissors are not allowed, the ruler or triangle in Template A is adequate. This should be cut out of two-ply chipboard so that you have a solid hard edge with which to rip sheets. See the image below.
- Base: A 14" x 17" to 18"x 24" board made of chipboard, cardboard, museum board, or multi-use art paper serves as a solid base for a collage. It allows for a range of large scale images coming from a standard magazine. If you choose a smaller size, you will be limited by the number and size of images that you can use.



Process

To start, pass out a base to each participant along with scissors. Small groups can share the adhesives, assorted papers, and piles of magazines. An ideal number of magazines would be two to three per person. If you are using whole magazines or if you have large images, participants can tear them by hand, cut them with the scissors, or tear them out with the Template A ruler. The assorted papers, along with pictures, can be folded, scrunched, or applied in a way that they project out from the board. Participants may focus on images alone or write or draw on the collage. Encourage participants to be creative with their use and application of these materials and to think intuitively, rather than analytically.

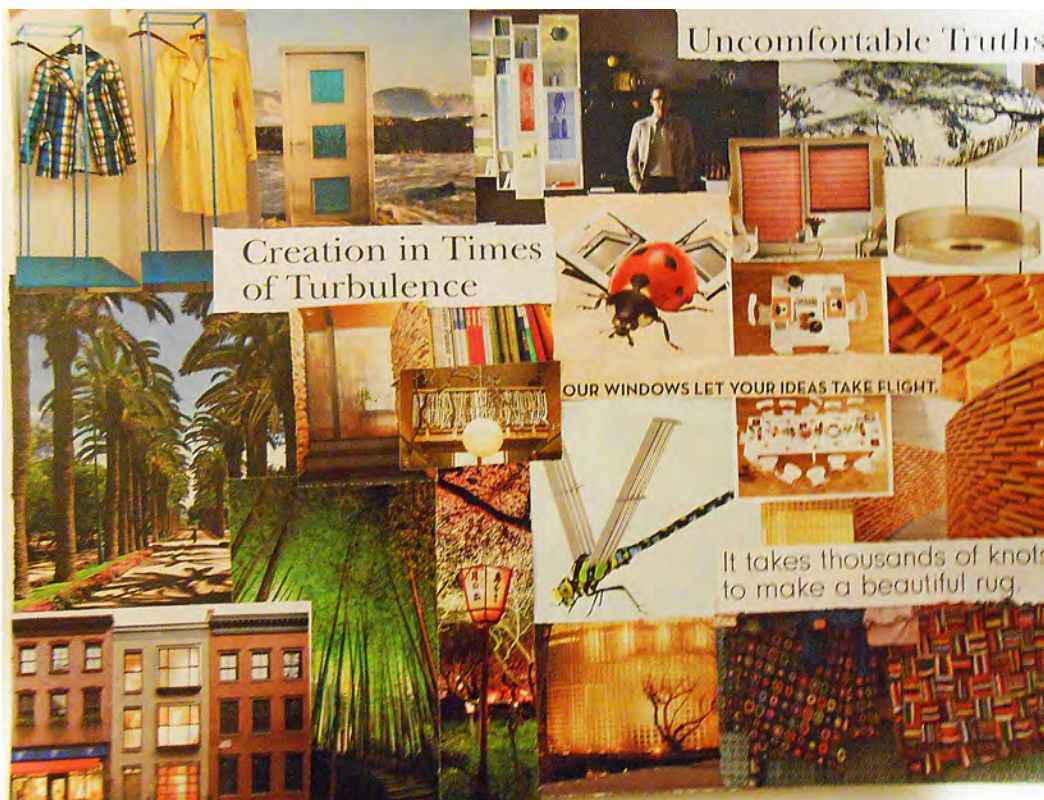

Resources

The Collage Workbook: How to Get Started and Stay Inspired by Randel Plowman (Lark, 2012).

Tool
2



Participant Handout

Collages

Collage – pulling together a collection of images and organizing them in a single composition – is an easy way to explore concrete design ideas for a space or explore feelings such as love and forgiveness and how they relate to the design of justice spaces. Images seen in relationship to one another can take on new associations and more complex meanings than they do just on their own. Collage is useful when we do not feel comfortable drawing or sketching, and the use of photographic imagery can be helpful in conveying more complex emotions, intentions, systems, and ideas. In the case of restorative justice, collage is also a helpful tool for representing spaces that may draw on our past experiences and our visions for a new one.

Collage activity

In this activity, you will be creating a group collage that will include your chosen images as well as those of other participants. Consider the following:

Reflect on the current criminal justice system as well as a criminal justice system that would be based on love. Select one or two images that represent the design of each of these justice approaches.

After everyone has selected their images, you will share your images one-by-one and explain how they represent the current justice system and a system based on love. You will then affix your images to the collage. After everyone has shared you will discuss the collage.



Tool
2



Templates

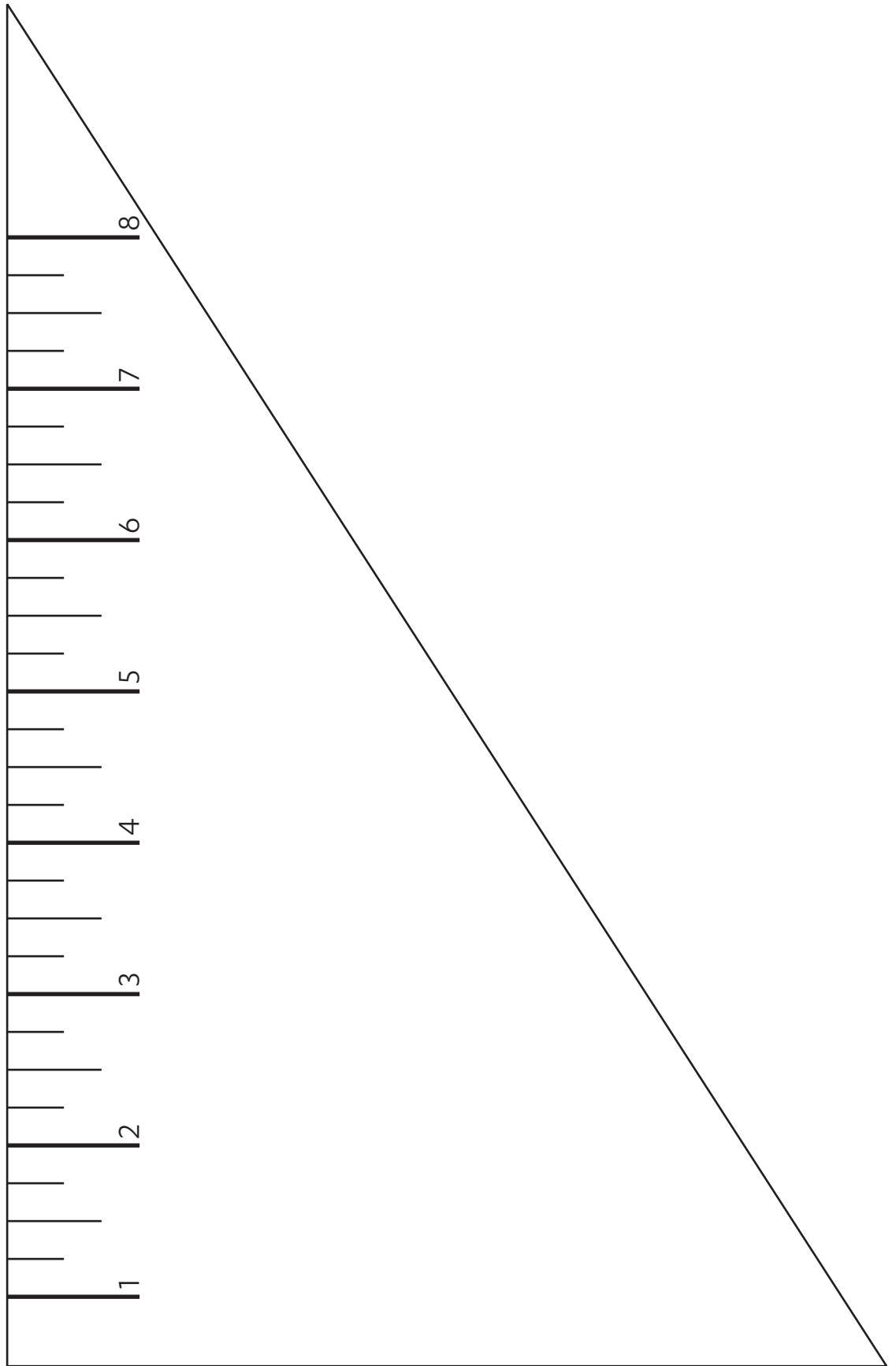
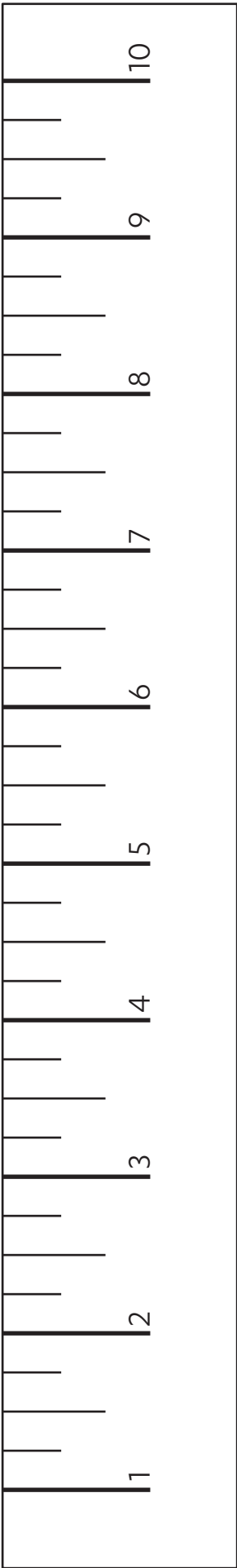

Tool
3

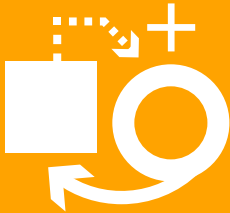

Diagrams

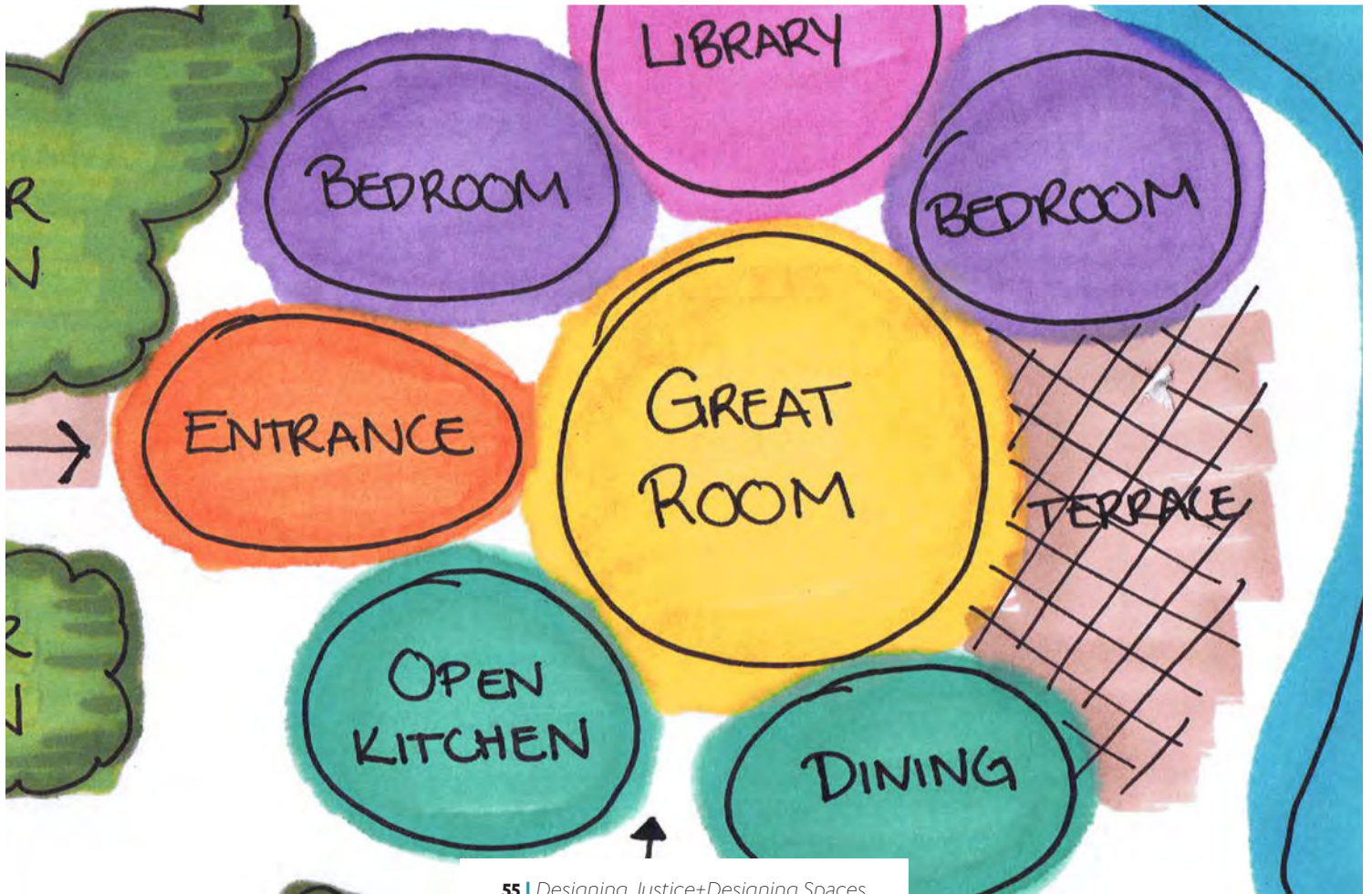



Description

Diagrams

When we want to understand how people use spaces and what kinds of relationships exist between complex social interactions and spaces, we can use bubble diagrams and graphic symbols to express these relationships in a simple way. Color, lines, arrows, and shapes integrated with text can all help to explain what we see, experience, and observe in the world around us. This becomes an important exploration prior to the creation of complex and detailed representations of space, such as measured drawings or renderings. These diagrams are always used at the beginning of any design phase, no matter if you are designing a new city, a building, or a single room.

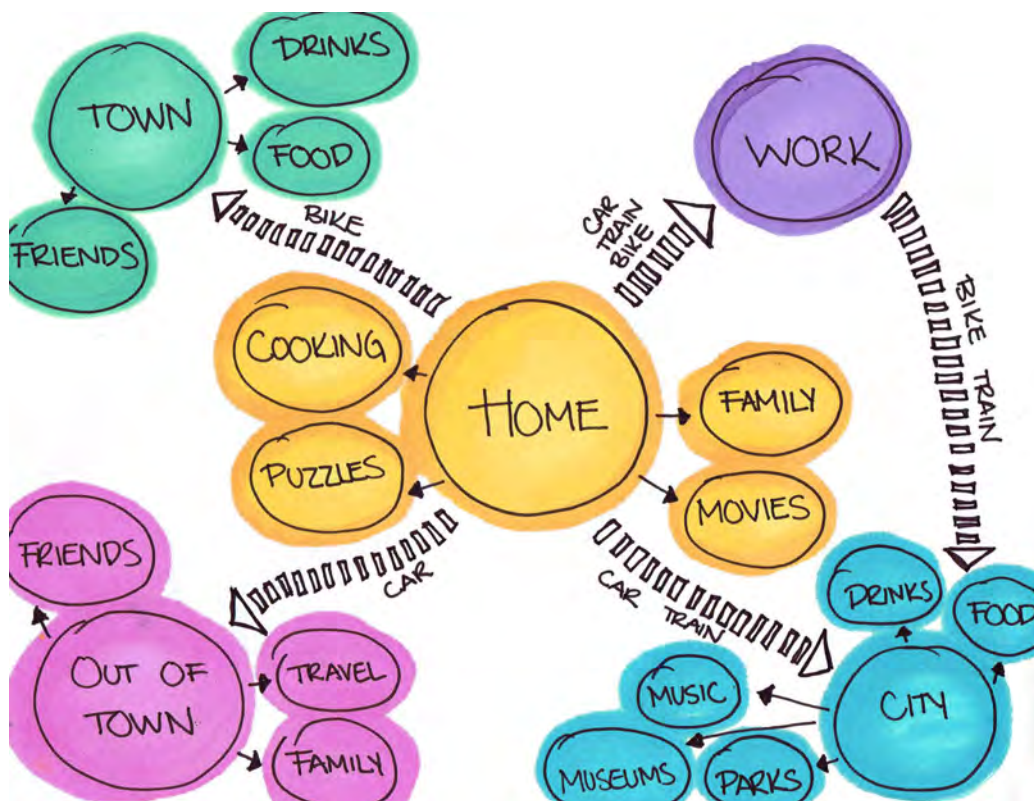

SAMPLE EXERCISE

This exercise invites participants to consider the spaces in which they live, work, and play that communicate values important to restorative justice, such as love and respect. These spaces may be inside the institution or outside in the community. After giving students an introduction to diagrams and aspects of design to be considered and then showing examples of diagrams, provide participants the following prompt:

Consider the different buildings and spaces in which you live, work, and play and in which you experience values important to restorative justice, such as love, respect, and empowerment. Select one of these spaces and diagram it.

After students have completed their diagrams, facilitate a large group discussion. Sample questions include:

1. What have you chosen to represent and why?
2. How are you representing your ideas/experience of the space?
3. How might others' diagrams of similar spaces be similar to or different from the one you created?
4. What parts of the existing diagram would you want to change and how? What new experiences would this change promote?

“I love thinking visually so that was an exciting aspect for me. Visual practice helps be integrate academic discourse into my thoughts/ideas so it was very helpful.”

– Chester Prison Workshop
Participant



Plan and Process

Use this tool to

- Explore personal and relational experiences with spaces.
- Visualize and/or map power dynamics within a space.
- Begin to visualize experiences that one wants to transform within a space.
- Understand movement through spaces.
- Compare and contrast different experiences within a space.
- Explore restorative spaces at various levels (e.g., room, building, neighborhood, city).

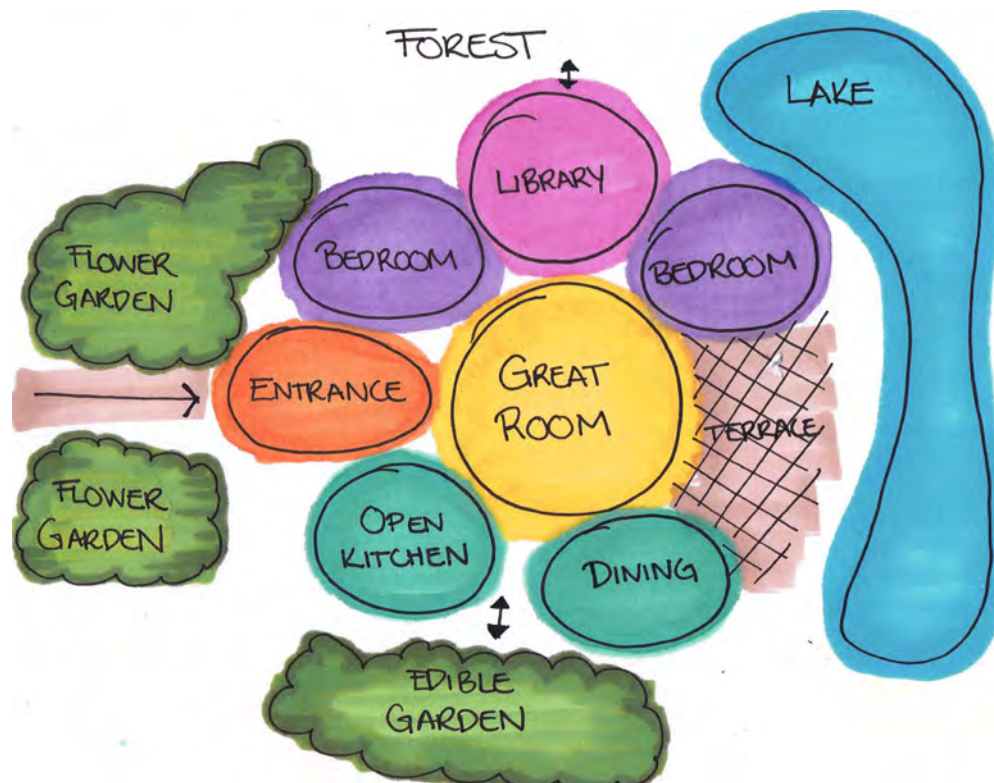

Modify the sample exercise

Variations of this design tool involve the prompts provided to participants and the way in which diagramming is created and completed. These prompts can be used to create diagrams that are drawn but also ones created with moveable pieces. Additionally, participants can create diagrams individually or work together in small groups to make one diagram.

Prompt 1: Restorative justice, social justice, and design

1. Consider the different buildings and spaces in which justice occurs. Diagram for:
 - a. Spaces that perpetuate or send messages about racism, oppression, power imbalances, and other social inequalities and discrimination (e.g., socioeconomic status, gender, sexual orientation, disability).
 - b. Spaces that contribute to or send messages about equality, freedom, participation, and empowerment.
2. Consider the spaces in which you live, work, and play in every day, and diagram the same experiences and messages as above.

Prompt 2: Diagram your life

Spend time reflecting on a typical day and draw a diagram that represents your experience in any way you like. To start, think about the places where you spend your time. What are the sequences of events and how do you get from one place to another? Where do you rest, play, work, and worship? Are the spaces close to one another? Does it take a long time to get to each space? What barriers might be in your way? Where are the points of access? Are you below or above ground? Who do you meet up with on your way? Are there multiple scenarios you can explore?

Exercise 1: Adding symbols to a drawn diagram

A simple modification to any drawn diagram exercise involves inviting participants to use symbols that represent furniture to further specify, or transform, the space. Provide participants with paper furniture cutouts created from Template 2 in the Make and Build section.

Present and debrief the design tool

Students present their diagrams to the group. Sample debriefing and discussion questions include:

1. What have you chosen to represent and why?
2. How are you representing your ideas/experience of the space?
3. How might others' diagrams of similar spaces be similar to or different from the one you created?
4. What parts of the existing diagram would you want to change and how? What new experiences would this change promote?





Make and Build

Diagrams can be simply drawn on paper, on tracing paper, over a map/image, or created with movable pieces. Varying supplies and preparation are needed for each type of diagram.



Diagramming on paper

This is the simplest and easiest form of diagrams as participants can create diagrams by drawing, by hand, on a piece of plain paper, on translucent tracing paper, or in their visual diaries.

Materials

- White paper of any size and weight (e.g., visual diary, 8 ½" x 11", 11" x 14", or larger).
- Felt tip markers in assorted colors (e.g., Pentel®, Crayola®).
- Pencil with eraser.



Diagramming over a map or image

Participants can create diagrams on tracing paper over a map or image as a way to diagram experiences within that particular space.

Materials

- Map or image of any size.
- Tracing paper: This can be found at most art or drafting supply stores. When purchased in a roll, participants can rip off the size of trace needed given the size of the image.
- Pencils.
- Felt tip markers in assorted colors (e.g., Pentel®, Crayola®).



Diagramming with moveable pieces

This process requires the most preparation but can be a helpful tool when participants are working in groups or have a focused objective for the diagram (e.g., diagramming a new building or neighborhood design). Participants use moveable paper “game pieces” and arrow cutouts on a piece of paper to create diagrams. Simple colored shapes can serve as different types of spaces, which participants label themselves. You can also write or pre-print words or images to guide any themes you would like to explore in these diagrams. If you are a designer, you might have software that can create circles with text inside. If not, you can create them in a word processing software. For both processes, you can use various hole-punch sizes to cut out the circles or you can, of course, cut circles out by hand.

Materials

- Poster board or other paper on which to create and/or glue the diagram.
- Glue sticks or tape.
- Felt tip markers in assorted colors (e.g., Pentel®, Crayola®).
- Paper arrows (can be hand drawn or printed from the computer and cut out by hand).
- Card stock in assorted colors (65-85 lb is preferable for durability and clarity). Construction paper of assorted colors can also be used.
- Large-scale hole/shape punchers: These punchers allow one to quickly make different shapes with a single punch (e.g., circles, ovals, squares, straight or scalloped edges). Used by those who make scrapbooks, these can be purchased in most craft supply stores (e.g., Michael’s or AC Moore).

In advance of class, use the shaped hole puncher or scissors to cutout shapes in various colors and sizes and determine generally what each shape/color means. For instance:

- Green circle = natural space or feature.
- Blue oval = water.
- Yellow circle = room.

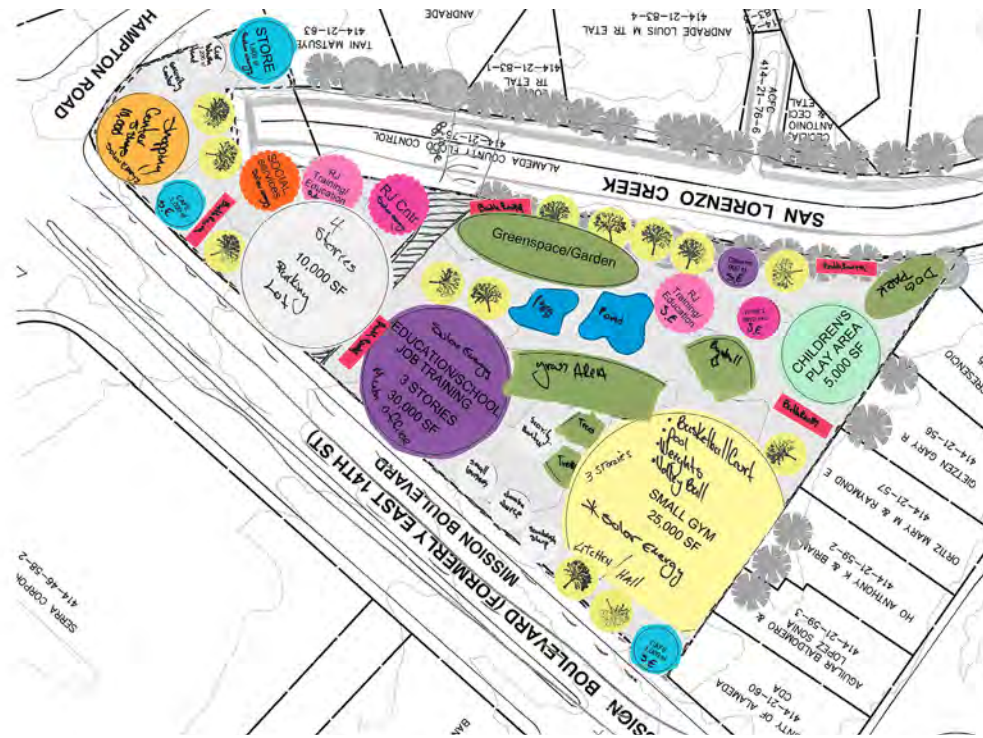

Diagramming with symbols over a plan

This process requires some preparation but can be a helpful tool when participants are working with a plan of a space/building and want to be more specific about the uses of the space. In this process, participants use moveable paper “game pieces” of furniture and arrow cutouts. Template 2 provides some suggested elements for working in incarcerated settings and can be printed on different colored papers for clarity. If you are a designer, you might have software to create other furniture symbols.

Materials

- Printout of a plan of space with which you want to work.
- Glue sticks or tape.
- Felt tip markers in assorted colors (e.g., Pentel®, Crayola®).
- Paper arrows (can be hand drawn or printed from the computer and cut out by hand).
- Card stock in assorted colors (65-85 lb) is preferable for durability and clarity. Construction paper of assorted colors can also be used.
- Envelopes (to hold and carry cutouts).

Decide on a cardstock color for each category of furniture (e.g., green for outdoor or nature-related furniture/feature) and print one set of furniture symbols for each small group. In advance of class, use scissors to cut out the furniture symbols, and put one set of symbols in envelopes, one for each group.

Tool
3

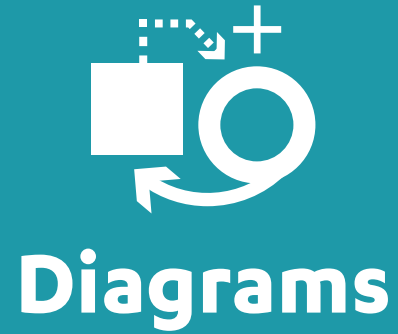

Participant Handout

Diagram exercise

Reflect on the following prompt:

Consider the different buildings and spaces in which you live, work, and play and in which you experience values important to restorative justice, such as love, respect, and empowerment. Select one of these spaces and diagram it.

When you have completed your diagram, reflect on the following questions:

1. What have you chosen to represent and why?
2. How are you representing your ideas/experience of the space?
3. How might others' diagrams of the same space be similar to or different from the one you created?
4. What parts of the diagram would you want to change and how?

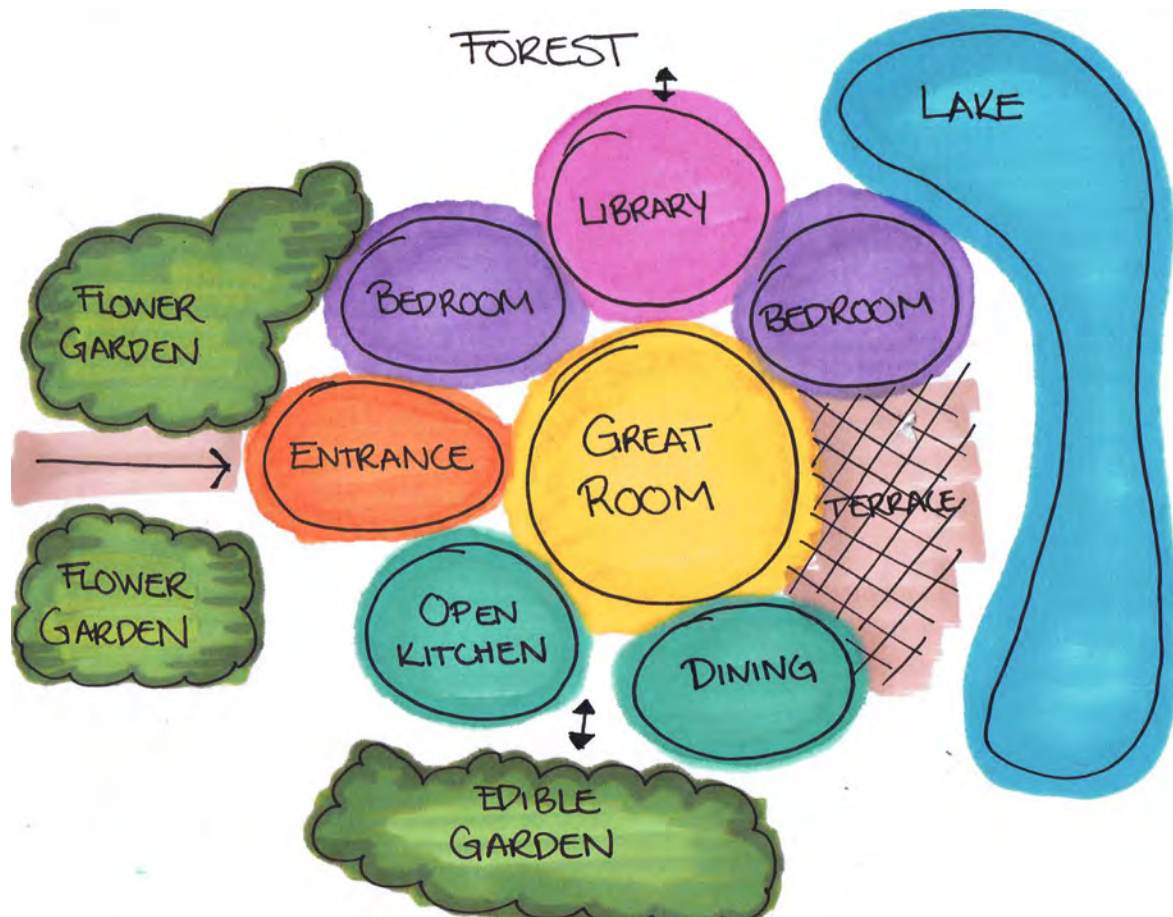

Tool
3

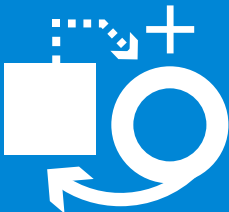

Diagrams

Templates

Space Dividers

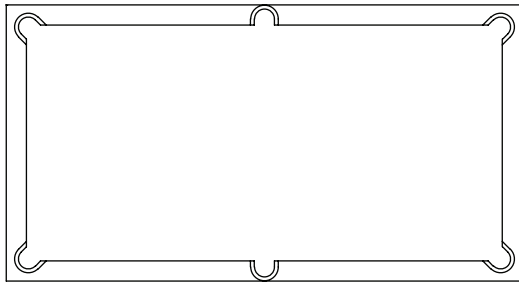

Pool Table

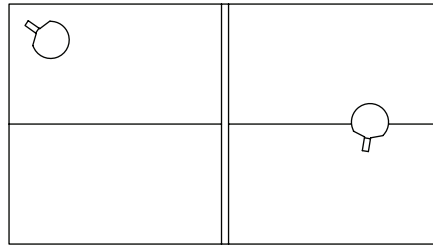

Ping Pong Table

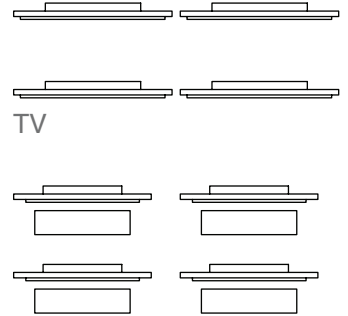

TV

Computer

Leisure 1/4"=1-0'

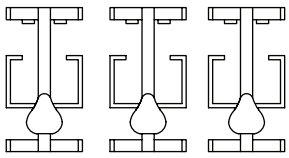

Rower

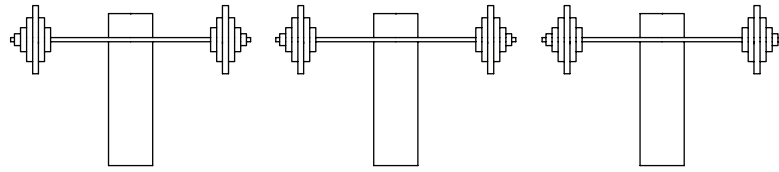

Weights

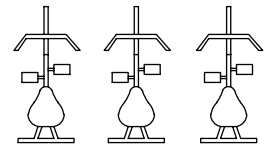

Bike

Fitness 1/4"=1-0'

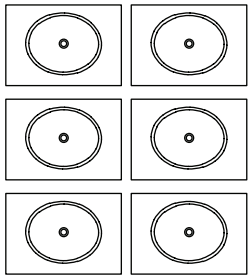

Sink

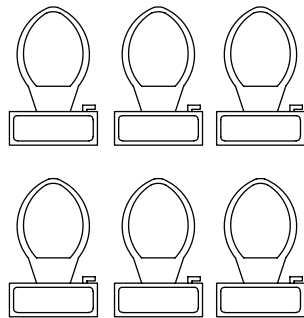

Toilet

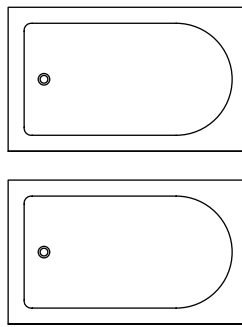

Tub

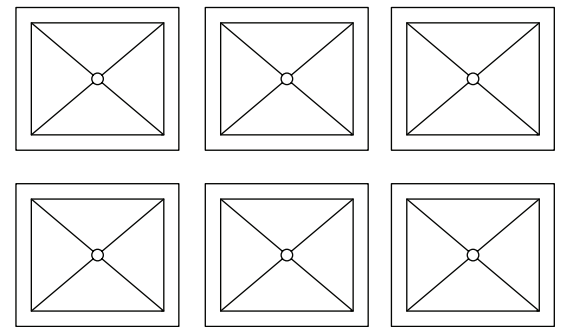

Shower

Bathroom 1/4"=1-0'

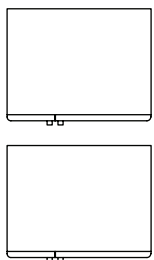

Refrigerator

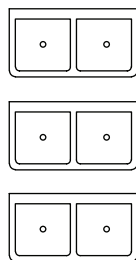

Sink

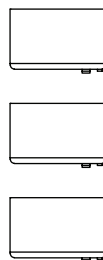

Microwave

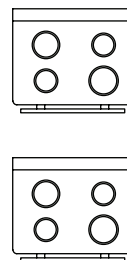

Stove

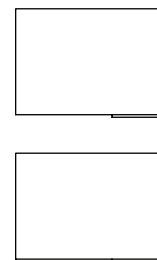

Vending Machine

Kitchen 1/4"=1-0'

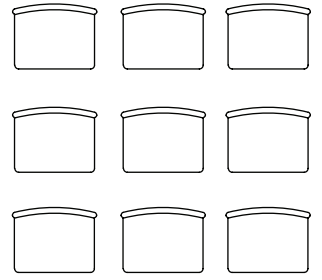
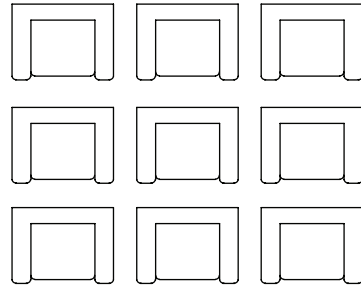
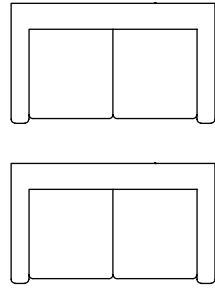
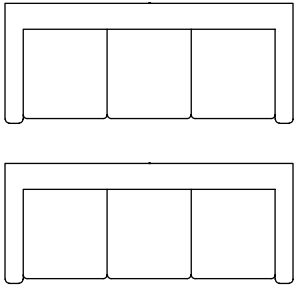

Seating 1/4"=1-0'

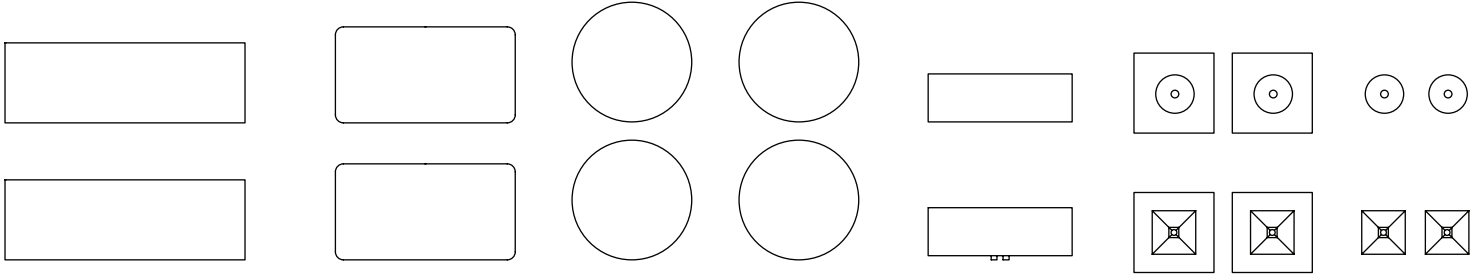

Coffee Tables - Cabinets - Lamps 1/4"=1-0'

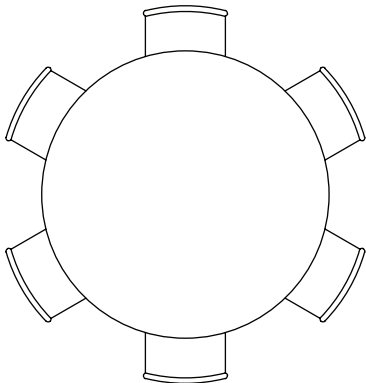

6 Person Table

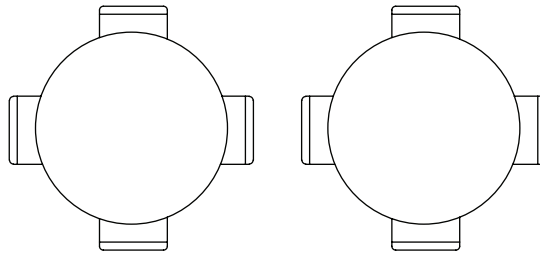

4 Person Table

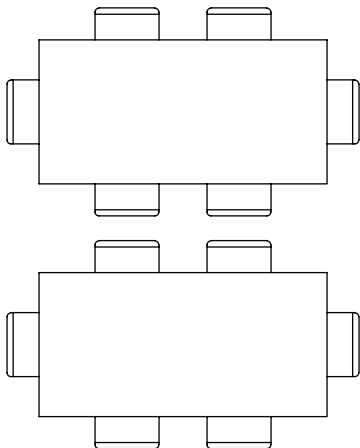
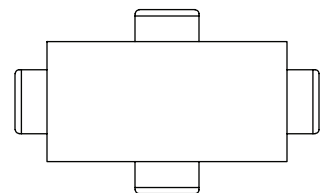
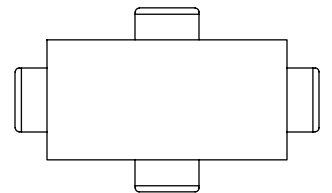
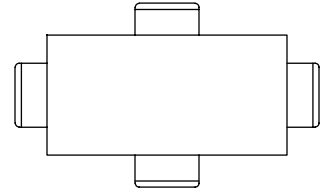
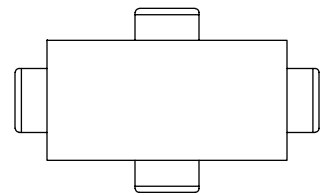

6 Person Table

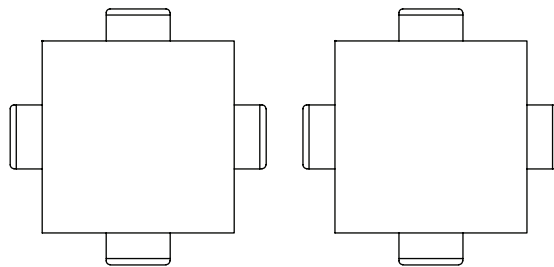

4 Person Table

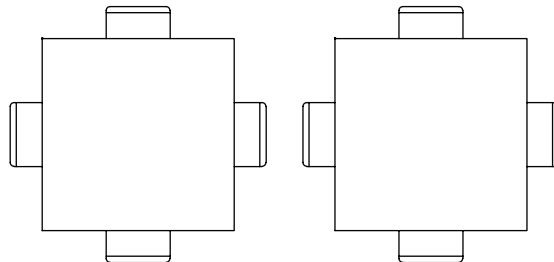

4 Person Table

Tables 1/4"=1-0'

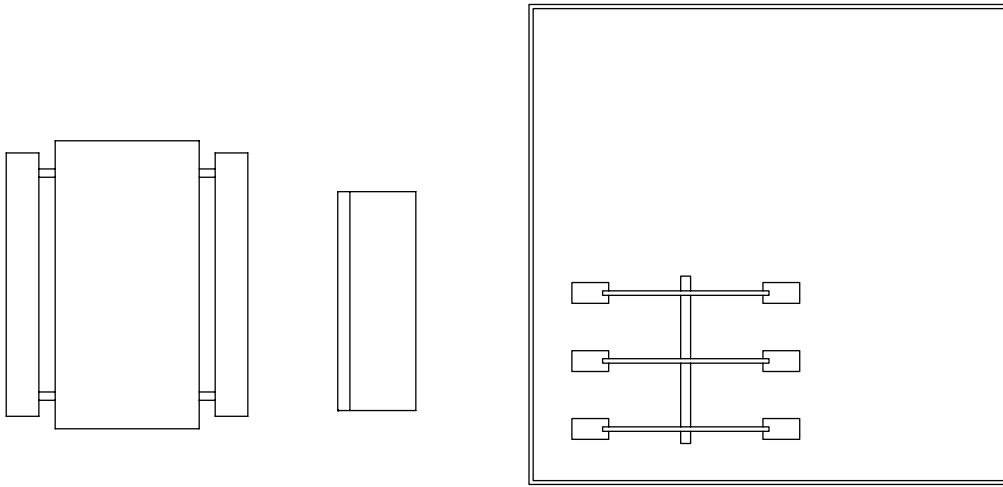

Outdoors 1/4"=1-0'

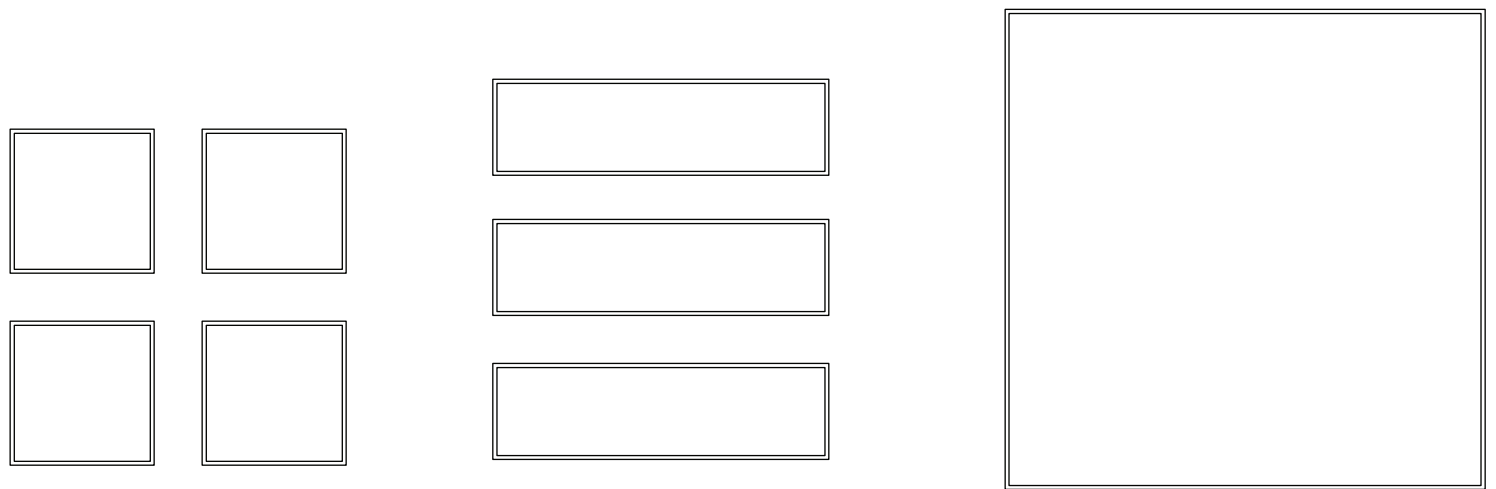

Gardening Plots 1/4"=1-0'

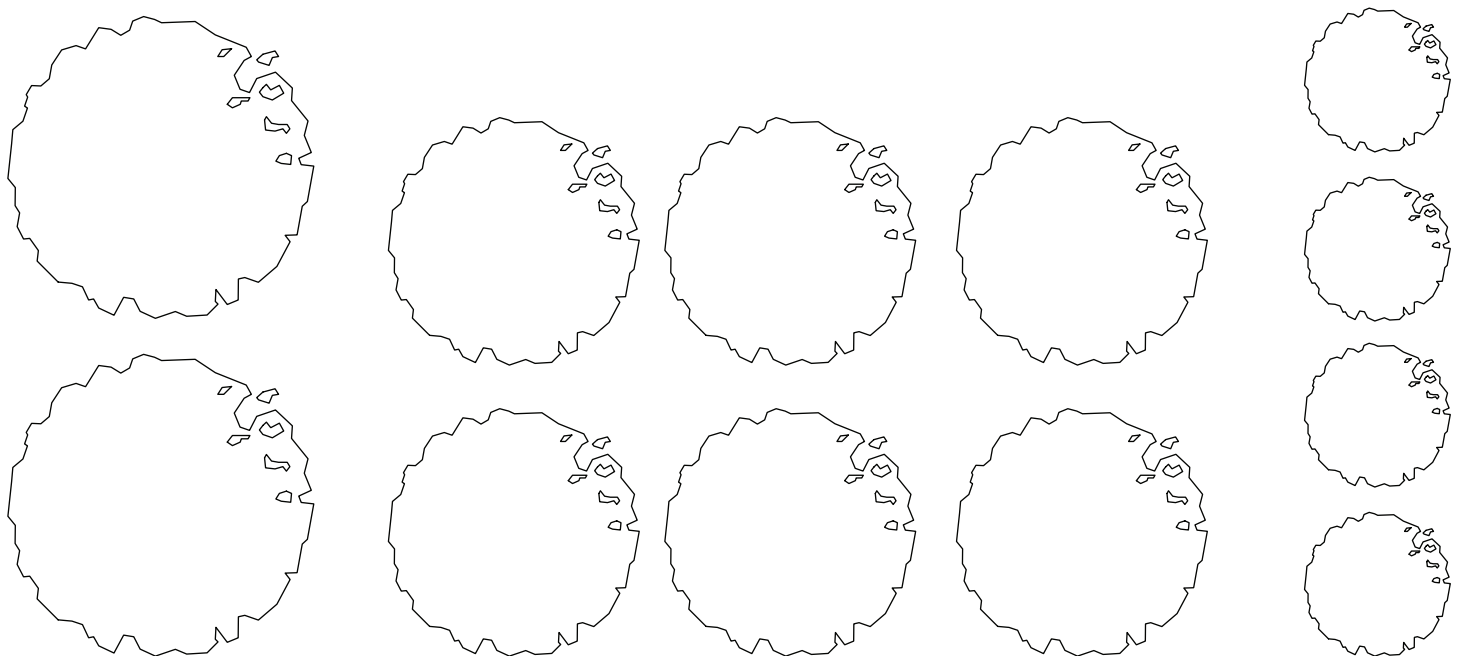

Trees 1/4"=1-0'

Tool
4

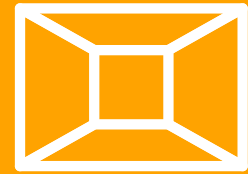

Perspective/
Montage

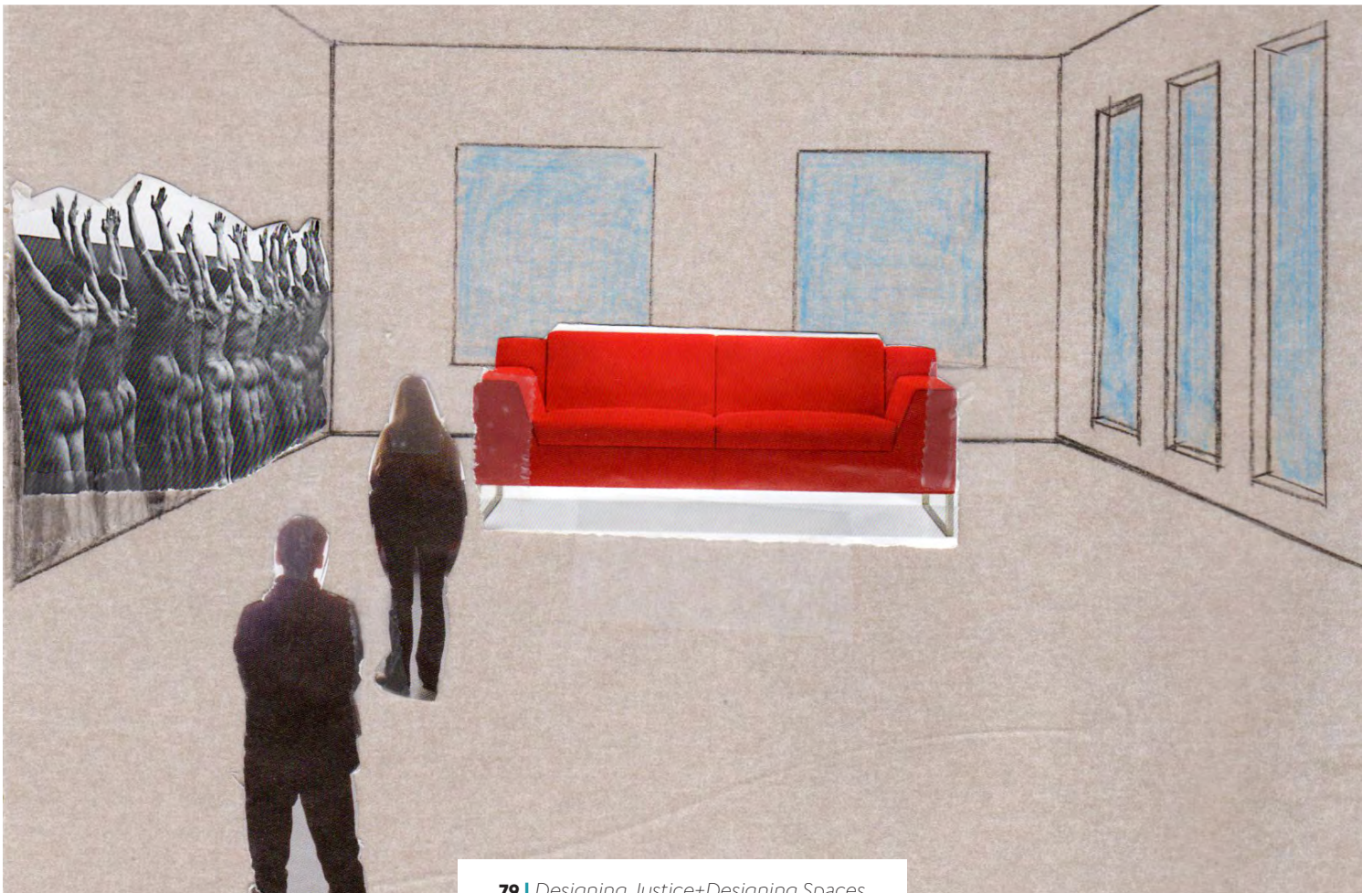



Description

Perspective Drawing

A perspective drawing is a two-dimensional drawing technique for representing three-dimensional space. Artists, architects, scientists, engineers, and designers have used this method for centuries to convey their ideas in a way that is often easier to understand than orthographic drawings, such as plans and sections.

There are several types of perspectives depending on your orientation and objects in a view. This tool and its activities use a one-point perspective, which means there is only one vanishing point along the horizon line (eye level). This is different from a two- or three-point perspective, where there are multiple vanishing points that correspond with the placement and angle of the objects in the room. You can read more about these elements in the Make and Build section of this tool.

These perspectives involve drawing or envisioning the “construction lines,” the lines that create the perspective or illusion of three-dimensional space. The activities associated with this tool use a variety of processes – working with room templates that already have the construction lines on them, drawing construction lines on images or photos, or creating one’s own spaces with construction lines from scratch. The Make and Build section includes detailed instructions on how to create these amazing images.

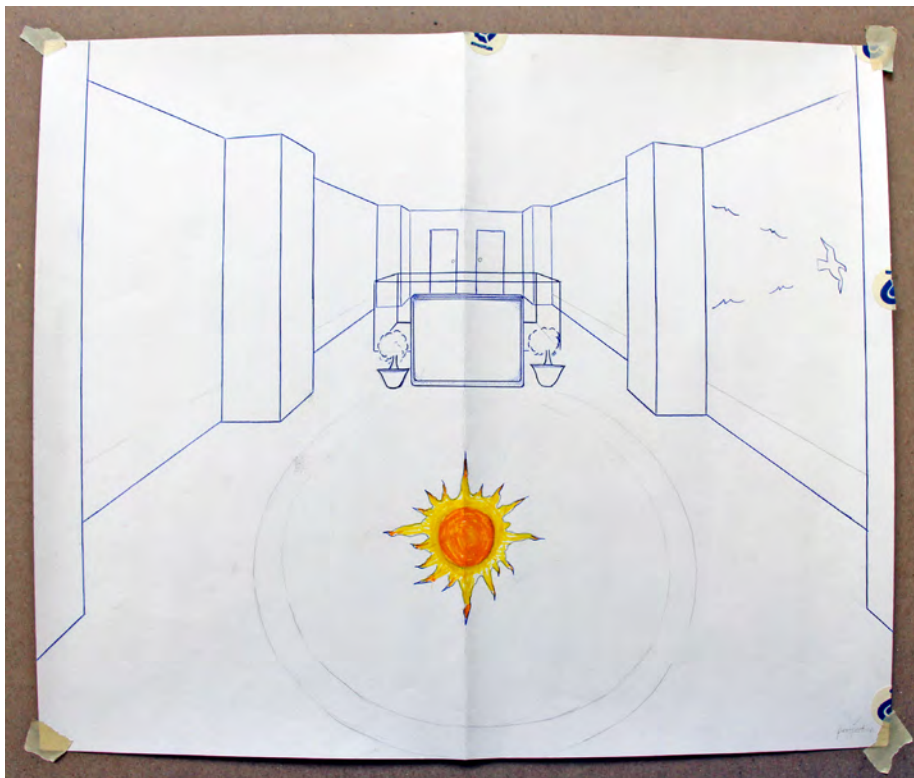



SAMPLE EXERCISE

Using Templates 3 and 4 in the Make and Build section, construct a perspective that will look like Figure 5 in the Make and Build section. These templates already have some construction lines (the lines that create the perspective or illusion of three-dimensional space) drawn on the plane. This will be used to teach the basic components of a perspective and to create a room that students will add features to. See the Make and Build section for instructions on how to draw, create, or place these elements.





Montage

Another technique that draws on both collages and perspective drawing is montage. Montage combines multiple two-dimensional media (e.g., images from magazines, photographs) to add a richness and depth to a photo or perspective that you have drawn. For example, we can add images from magazines that support the ideas taking shape in our minds. Colored pencils, construction paper, and ink pens can also be used to add detail and color.

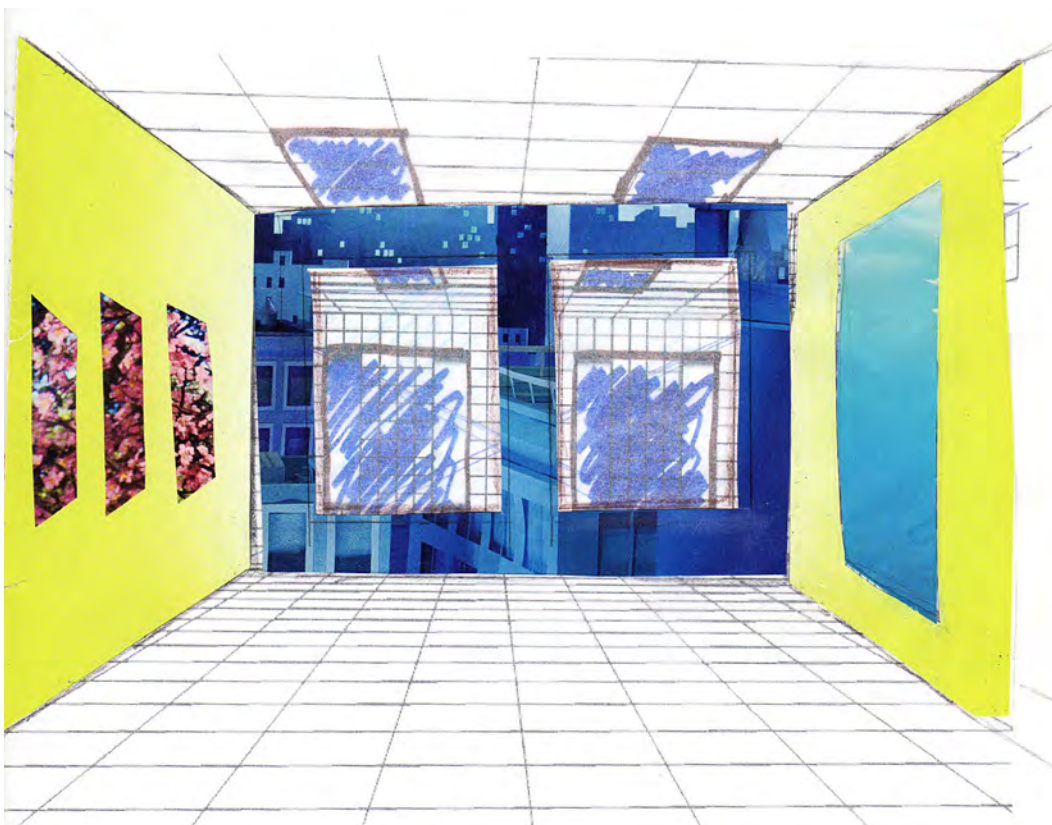



SAMPLE EXERCISE

Use the perspective you have drawn or take a picture of any space in your environment. Once printed out, you can cut images out of magazines and add them to your drawing or photo. Elements such as people, trees, furniture, and textures can be added to create a very rich perspective drawing that has the look and feel of a collage. It can be fun to move elements such as people around in the perspective and see how it impacts the way the space you have created feels.

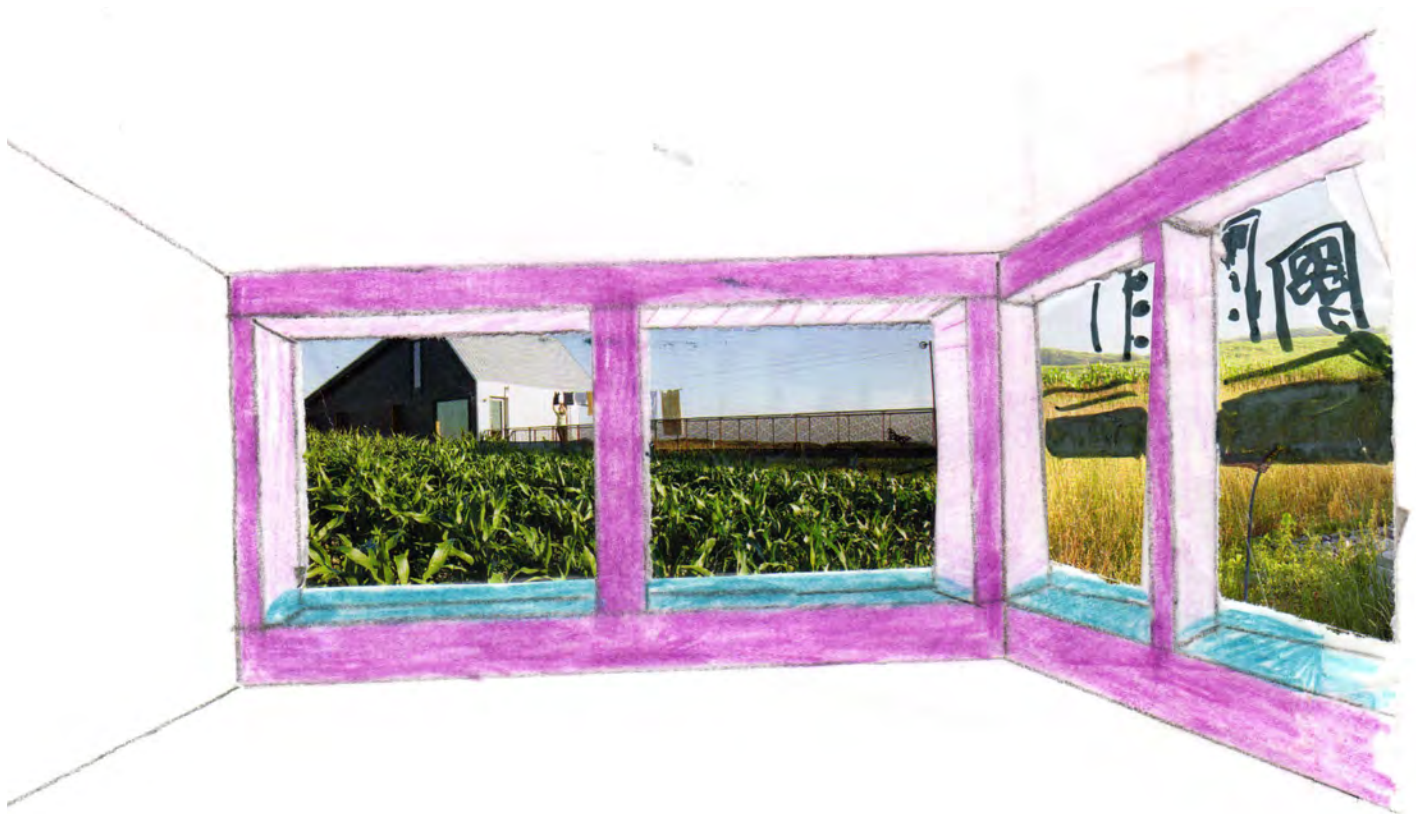



Plan and Process

This tool is useful to:

- Explore the different ways people experience the same space.
- Experiment with the modification of existing spaces.
- Discuss topics related to honoring varied perspectives of the same issue.
- Offer a tool that is more technical and structured for students who prefer this type of design work.
- Visualize completely new spaces from imagination.





Modify the sample exercise

Exercise 1: Practice with photos

Take a photo of a space in your environment, ensuring that you are parallel to the surface on which you want to draw (this is necessary for practicing one-point perspective). This may be a space in the institution, building in which the workshop is being facilitated, or another space familiar to all students (e.g., a courthouse). Print out the photo, and locate and highlight the basic elements of a perspective, such as the vanishing point and the horizon line. Place a piece of tracing paper over the image and begin to re-draw these elements and then add new elements as described in the sample exercise. See the Make and Build section for instructions on locating the basic elements and creating new elements.

Exercise 2: Redesign and renovate - Create a template of an existing space

A great final project for a class is to redesign a space they all know. This is often a place inside the institution, if working with incarcerated students. If students do not want to use a space in the institution, you can select a civic building to which everyone has been exposed. For example, a local courthouse or court room can be a prototypical building or space that you can use as a project. For this modification, you will follow a similar process to the sample exercise after creating your own template. See the Make and Build section for instructions on how to create this base template.

Exercise 3: Envision a new space

Some students want to create a space that is entirely generated from their creative ideas about a new kind of building or place. In this instance, students can use the techniques they have learned in the sample exercise to draw the space they have been envisioning. If students practice perspective drawing in their visual diaries and feel comfortable with this tool, there is no reason they should not be able to envision a completely new space without using templates or photos.



Present and debrief the design tool

Since students are often working from the same base template, discussion questions include:

- How do participants experience the same space?
- What commonalities exist across the perspectives?
- What differences exist across the perspectives?
- How might other people experience the space that you created differently than you have envisioned it?
- What design elements in the room support restoration, transformation, love, and/or forgiveness?
- What might you add to your perspective to support restoration, transformation, love, and/or forgiveness?
- How do participants' identities and experiences influence how they created the space?



Tool
4



Perspectives/
Montages



Make and Build

Perspective drawing can be one of the more challenging tools to teach but can also be one of the most rewarding as space magically jumps out from the page. This description is by no means complete or exhaustive and we recommend practicing yourself first, using the resources we have included. Adding color and images to the perspective to create montage can also help bring it to life and utilizes what students have learned in the collage tool.

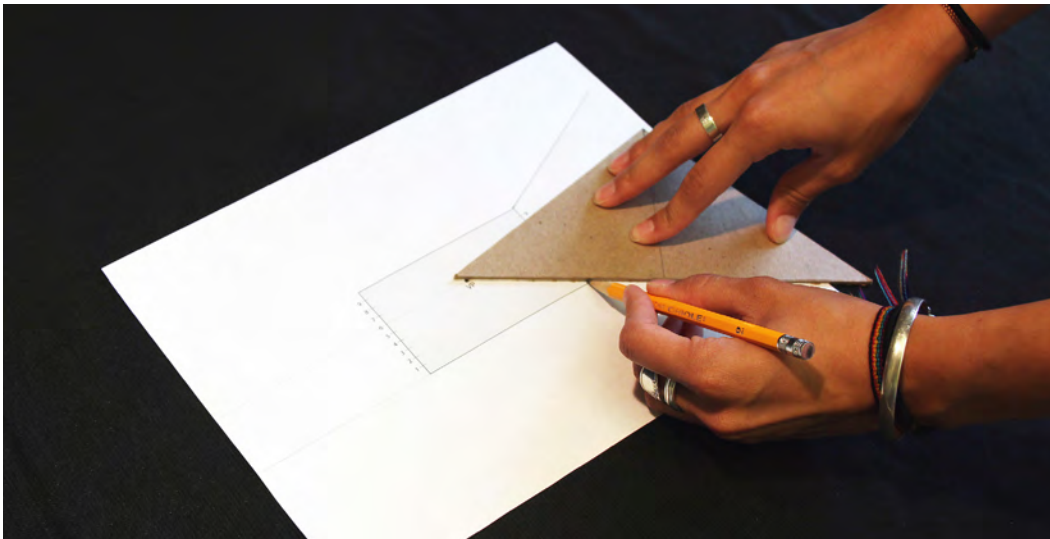

Materials

The materials for perspective and montage drawings are simple and can be done free hand with just a pencil and paper once students get more familiar with the process. In the beginning, use the following drafting tools:

- Pencil sharpeners.
- Erasers.
- Ruler and triangle: Rulers and triangles are used as guides to draw straight lines. As rulers may not be allowed into high security settings, use the ruler and triangle in Template 1. These should be cut out of two-ply chipboard so that you have a solid edge against which to draw.
- Paper and trace: If you are creating a perspective from scratch, paper of any kind will do but a thick paper such as a smooth two-ply Bristol board works well with pen or pencil. If you are working over a photo as a base then you will need trace (or tracing paper) to overlay on the image. This can be purchased at many art stores on rolls. We recommend 12" or 18" width.
- Magazines for cutting or ripping out images to add to the perspective, in order to create a montage.



Process

The following pages introduce how to create a perspective and include five figures with corresponding instructions. This section starts with an introduction to the basic elements of a perspective drawing, several rules for creating perspectives, and finally the instructions.

Basic elements of perspective

- Vanishing point: A point somewhere on the horizon line where receding lines (planes) converge.
- Picture plane (or elevation): A plane corresponding to the surface of a picture, perpendicular to the viewer's line of sight. It is the place to which all lines extending to the vanishing point are drawn. It is the plane off of which the heights of doors and windows in the perspective are taken.
- Horizon line: Line across the picture plane representing the horizon. It is always at eye level. Its placement determines where we seem to be looking from - a high place or from close to the ground. Elements in perspective above the horizon line are seen from below, and those below the horizon line are seen from above.
- Ground line: The line parallel to the picture plane at the base of the object or room being depicted.
- Station point: Represents the eye of the observer. It is the camera in a photograph.

Rules

- Surfaces of the room in the plan that are parallel to the picture plane do not extend to the vanishing point. For example, see the window on the picture plane in Figure 1 and the depth of the doors and windows in Figure 4. Elements and surfaces parallel to the picture plane, such as the tops and bottoms of the window and door on the left and right side of the room in Figure 3, need to extend to the vanishing point.
- All vertical lines in one-point perspectives are drawn straight up and down.





Creating a perspective over a plan

1

To begin, tape the plan image (Template 3) over the picture plane image (Template 4) so it looks like Figure 1. The plan is just a reference image to help you locate windows, doors, etc. in your perspective. For this perspective drawing, you will be adding elements to the picture plane image (Template 4). Lay a piece of trace over this assembly and follow these steps to begin your perspective.

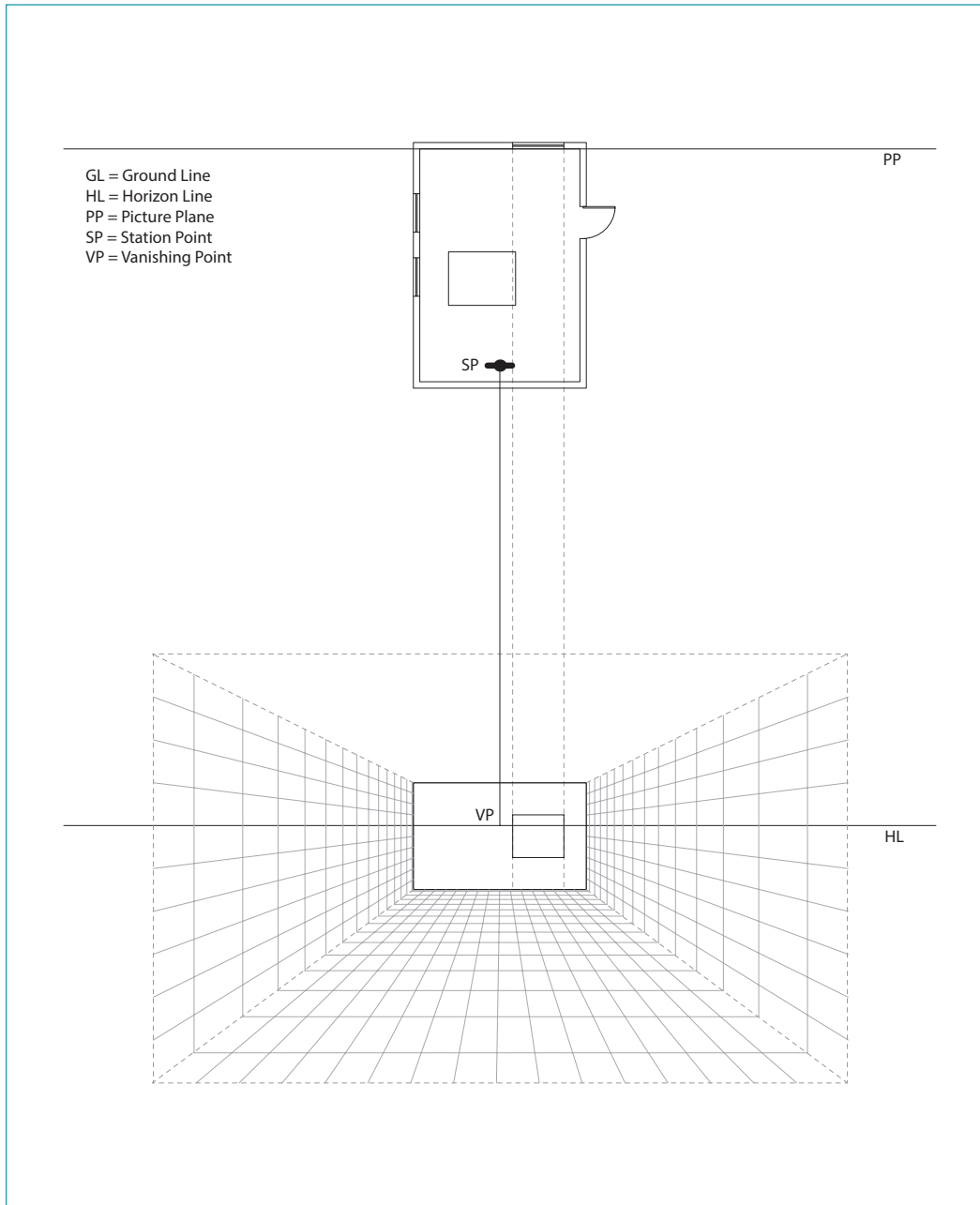

Figure 1



2

The second step is to draw in lines that will form the walls, ceiling, and floor of the picture plane. On Template 4, notice how there are dashed lines that form an “x” over the vanishing point (VP). When extended beyond the picture plane, these lines create the two side walls, ceiling, and floor of the room (see Figure 2). You can imagine yourself standing at the back of this “room,” looking toward the wall with the window.

Using your ruler and/or triangle from Template 1 and a pencil with an eraser, first draw in the four lines radiating from the corners of the vanishing point. The four lines represent where the walls meet the ceiling and the floor.

Next, you will create a grid. To do so, you will add more lines radiating from the vanishing point to form a grid. These lines will become reference points for adding in other elements in the room (e.g., windows and doors). To create these lines, align your ruler so it touches the vanishing point and the number or marks along the side of the picture plane and draw a line, extending out from the picture plane. Do this on both sides of the picture plane and do the same thing to create the ceiling and floor grid lines. Lines created on the ceiling or floor can later help you add ceiling features, such as lights or sky lights or carpets, tables and chairs.

The first element of the room that you will add is the window at the front of the room. Since this is not in perspective and is easy to understand, it is a good first feature to add. To do so, align your ruler vertically with the edge of the window in the plan image (Template 3) and draw a line straight down to the picture plane. In doing so, the edge of the window on the plane will now be at the same place as it is in the top image. Position the ruler on the other side of the window in the plan image and draw another line down into the picture plane. You can make the window height any dimension, using the height markers along the edge of the elevation/picture plane. Simply draw two lines connecting the two side lines and voila, you have a window. You and participants can add additional features to this back wall, if you are more advanced.

By now, you should be able to see the room taking shape.

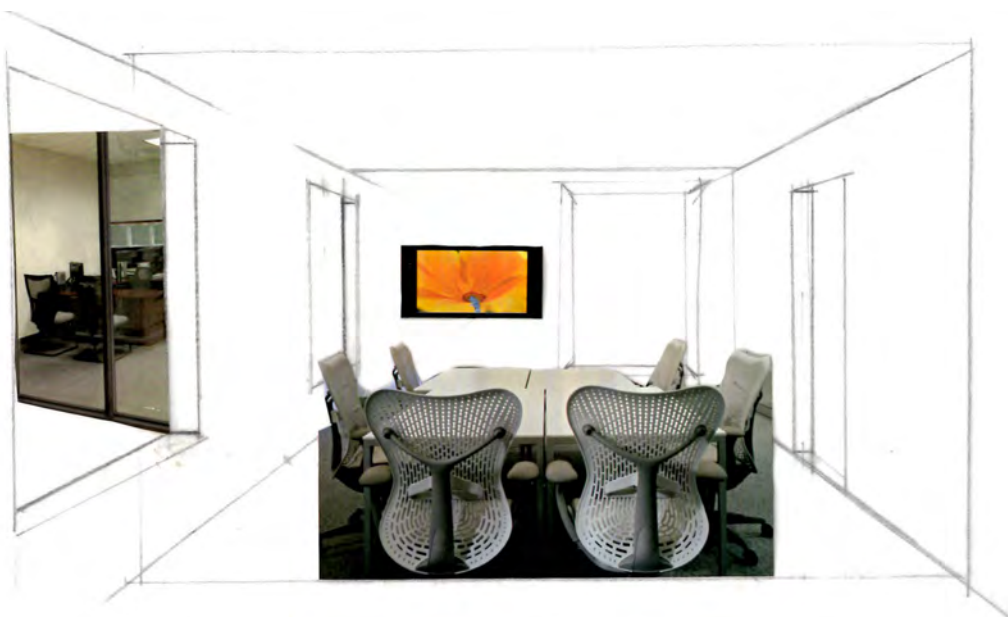

3

You will now begin to add features to the side walls, using the perspective view. The first feature will be the door on the right wall. Lines on the plan in Figure 2 help guide you on how to project lines for this step.

The first thing to do is to determine where the door in the top image will fall on the picture plane (see Figure 2). To do this, follow the dotted lines that indicate where to position your ruler. For example, in the top image, position your ruler so it runs from the station point (SP) to the top of the door and draw a line extending onto the picture plane line. Do this for both sides of the door.

Where these two lines intersect the picture plane is where you will draw two vertical lines down to your perspective to locate the door as in Figure 2.

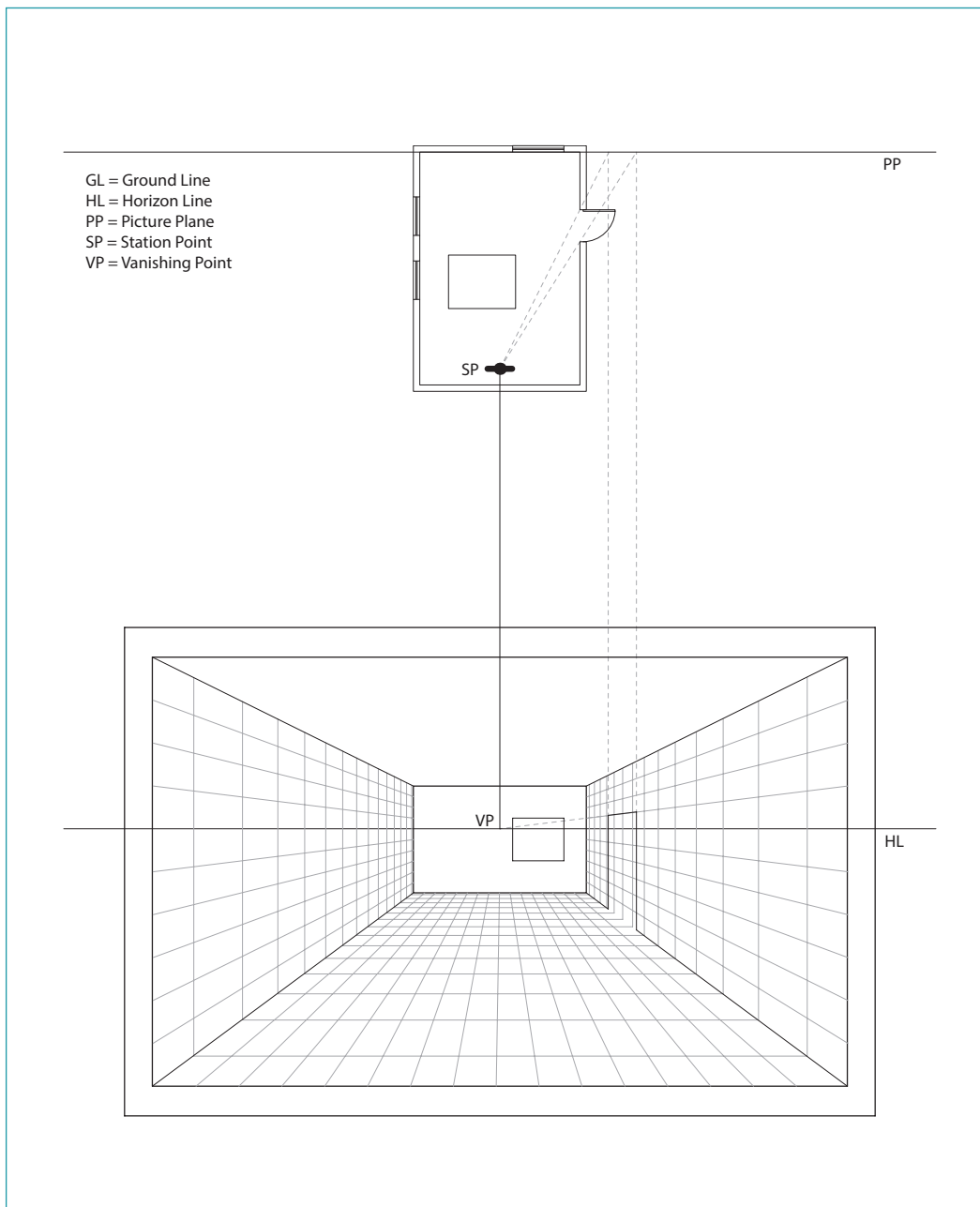

Figure 2



4

Using the same process you used for drawing the door, add the windows on the left side to the perspective (see Figure 3). Start again by drawing a line from the station point to each corner of the window until it hits the picture plane. Then, to create the sides of the windows, draw vertical lines like you did for the door down from the picture plane onto the left wall of the perspective. In your perspective, draw in the top and bottom of the window using lines radiating out from the vanishing point, at a height of your choosing.

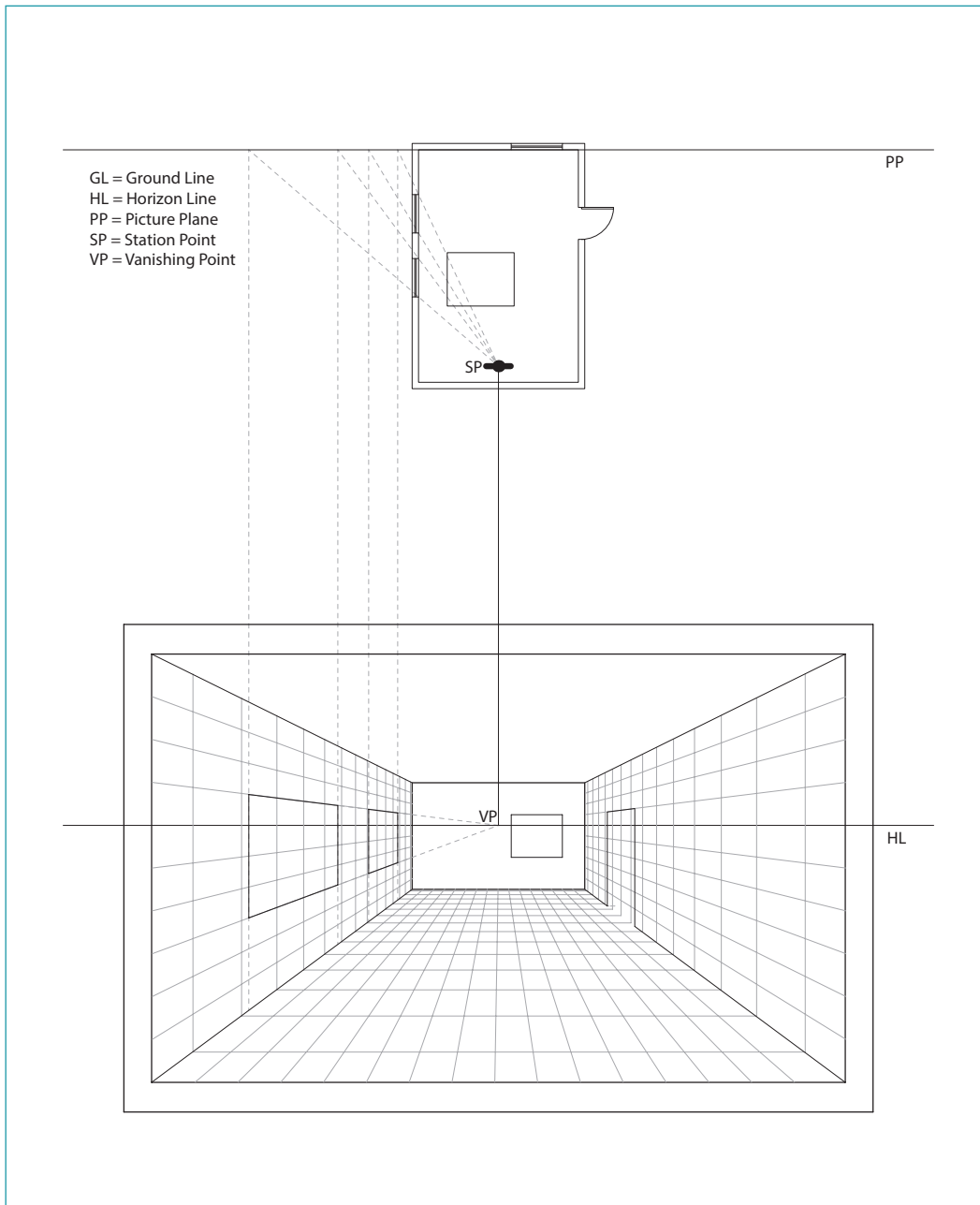

Figure 3



5

You are now ready to add depth to the walls, a more challenging task for people who are not architects/designers.

Remember that planes parallel to the picture plane have top and bottom edges that are aligned with the horizon line. See this element in Figure 4. To create depth for a window you will need to draw a shorter horizontal line that represents the width of a wall in the corners of your window. To do so, try aligning your ruler with the horizon line and slide up or down to the corner of the window and draw a line to the left away from the center of the room. The length of this line is the depth of the window.

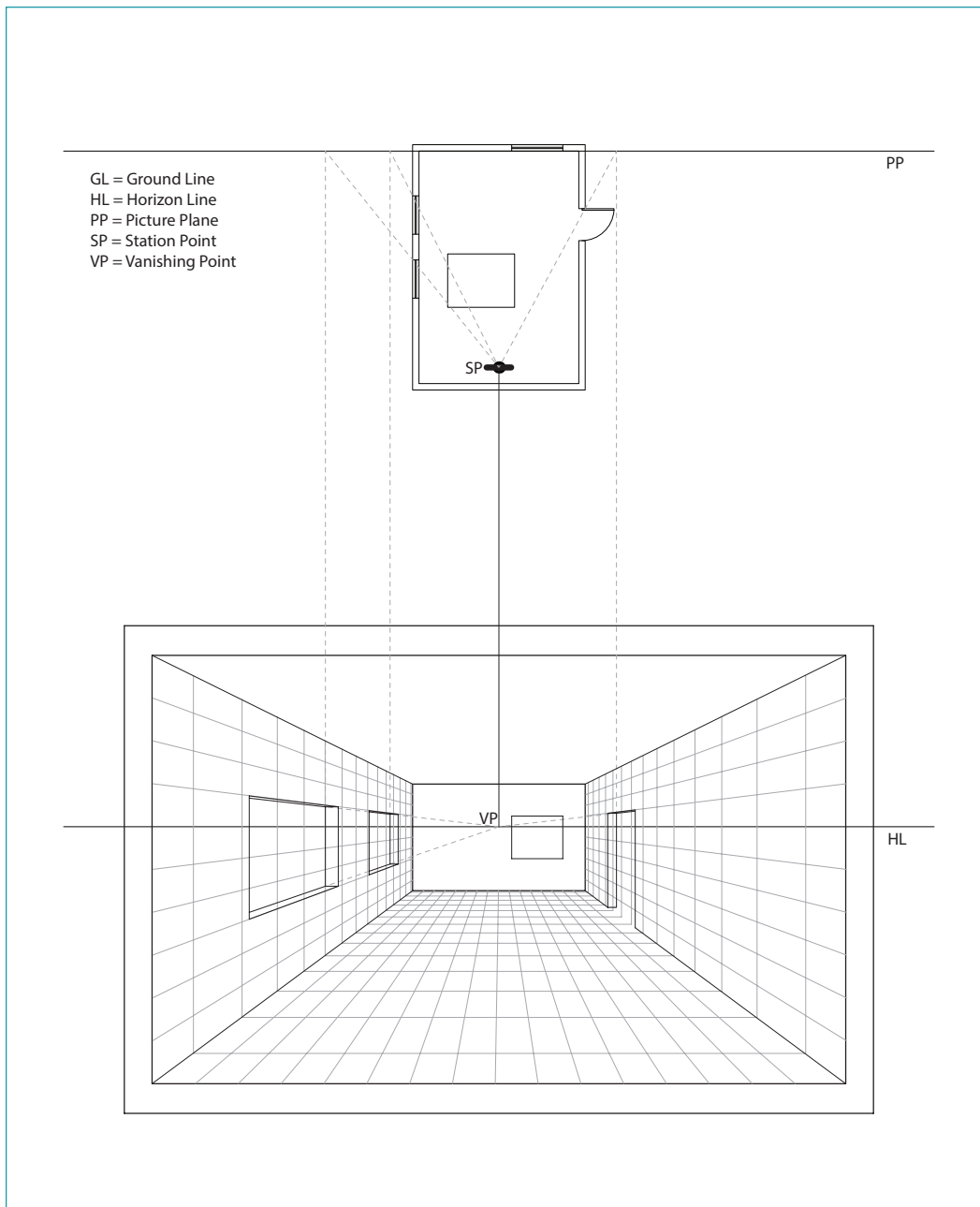

Figure 4

You can estimate the depth that feels right to you or to get the exact depth of the window you see in the plan, you can again project a line from the station point to the interior corner of the window or door that you will see in the perspective and follow the same steps as in 2 and 3. When you pull the line down from the picture plane, it will tell you where to stop this horizontal line and you will have a rectangular plane that represents the wall depth at the window or door.

6

You can now use the grid of lines across the walls, floor, and ceiling as guides to add new elements to the floor, ceiling, and walls or to create objects in the room, like the box in Figure 5.

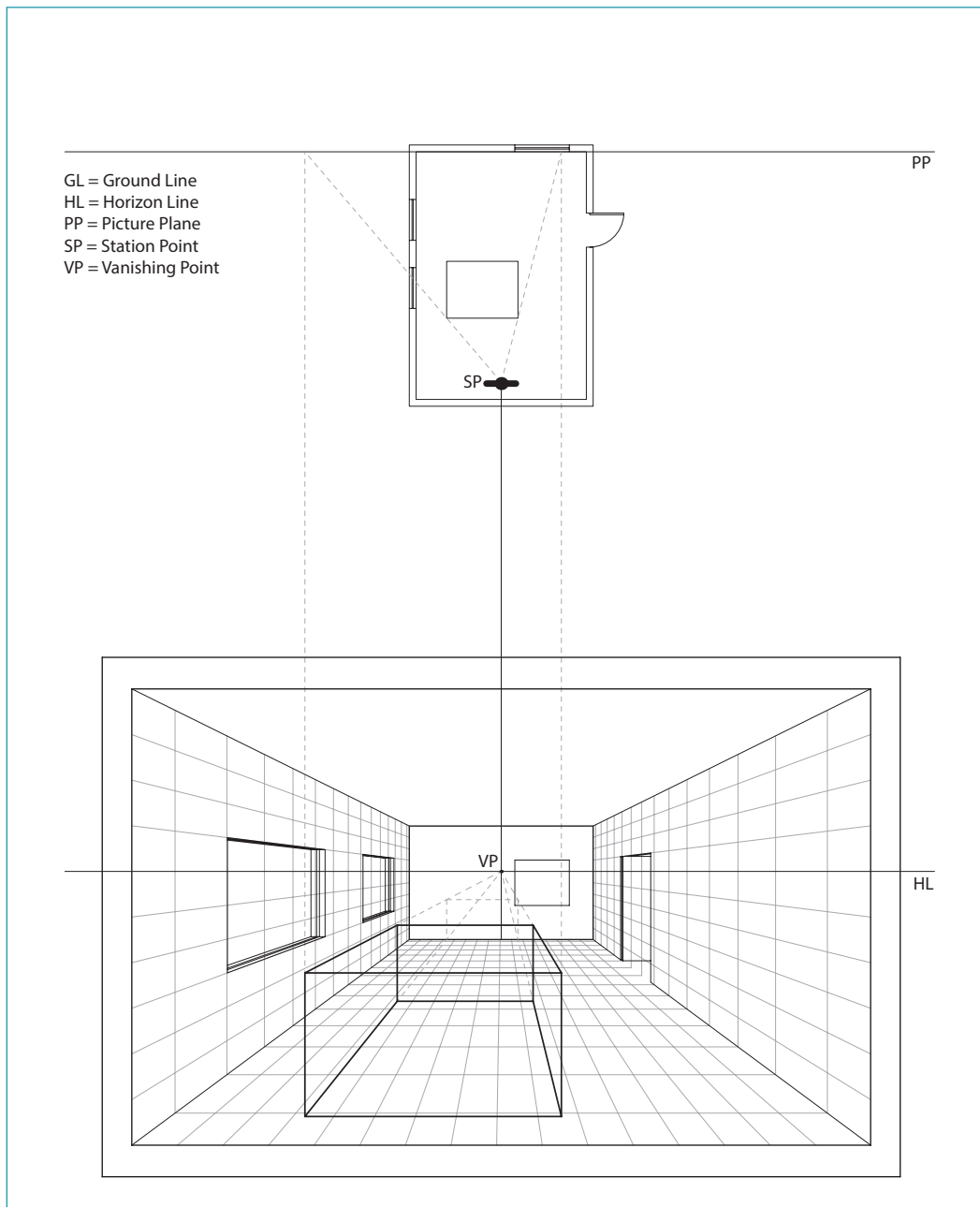

Figure 5



Practicing perspectives with photos

Drawing over a photo is another way to expand one's understanding of the elements of a perspective using a space that may be familiar to participants. It is still helpful to use the templates to help identify the elements in the photo.

1. Tape the image onto a flat working surface or rigid paper/board.
2. Locate and outline the basic elements: vanishing point, picture plane, and horizon line in a thick pen so you can see them through the trace paper overlay.
3. Lay the trace over it and outline the key elements again in pencil or pen before you begin adding new features or making design changes to the image.
4. Just like the perspective template, it is helpful to create a series of lines along the picture plane to create a grid guide that you can use to locate elements in the space and on the walls.

Create a template of an existing space

This process requires a bit more preparation and is primarily geared toward designers but can be very effective at helping participants to revision a space that they know inside the institution or without the confusion that can be created when a photo is below the image.

1. In order to create a base template of an existing space for you to work from, you will need to measure the entire space, locating the overall dimensions including the ceiling height and locations of doors and windows. If developing a space inside the institution, one way to do this is to pace or walk the space to get these measurements since you can't take photos or get a tape measure into most institutions. Typical techniques for measuring height, length, and depth that designers use is counting wall and ceiling assembly units. For example, most rooms have acoustic ceiling tiles that are often in a 2" x 2" grid. The walls are usually concrete, masonry units, or bricks, and while they can vary, bricks are usually 4" and concrete masonry units are 8" x 12". If you are not able to get a rough measurement of the space itself, you may ask participants or jail staff to get them for you. This is a helpful technique to provide your stakeholders with if they are incarcerated as you may not be able to access spaces that they can. However, one should understand that in doing so this activity could be considered a security breach.
2. For designers, this base information can be drawn up by hand using an architect's scale, modeled in a three-dimensional software like Sketch-up or digitally drafted. Either way, you can use this information for both perspective drawing and model making.

Envisioning a new space

Often, once participants understand the basics of perspective drawing, they can create their own perspectives quite easily. Sketching by hand in visual diaries is a good place to practice and doesn't require the ruler or triangle once participants become comfortable with this technique.



Process for montage

Turning the perspective into a montage is easy and helps participants understand what they are seeing. It can be done over a perspective you have created or a photo you have taken that you would like to enhance or change.

1. For this phase of the design you can use the ruler or scissors to cut out images from magazines that will roughly fit into the size of the perspective you have drawn. Various pieces of furniture, people, lighting, or plants are great choices.
2. Once you have cut them out, move them around the perspective until they feel like they fit within the image in terms of size. For example, a person should not be a giant in the room. Use your window or door to test this.
3. Next, cutouts of outdoor scenes or sky can be dropped in behind windows to show that there is an environment outside of the room.
4. Finally, you can add color to walls, floors, or ceiling with colored pencils. Pens often overpower the image.

References

Basic Perspective Drawing: A Visual Approach by John Montague, John Wiley & Sons, Nov. 8, 2011 and includes access to online tutorials.

Video: How to Draw a Room with a One Point Perspective: www.youtube.com/watch?v=yEymlyLbiAI

Tool

4

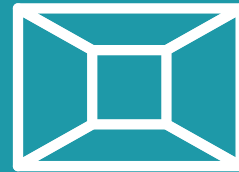

Perspective/
Montages

Participant Handout



Perspective

A perspective drawing is a two-dimensional drawing technique for representing three-dimensional space. Artists, architects, scientists, engineers, and designers have used this method for centuries to convey their ideas in a way that is often easier to understand than orthographic drawings, such as plans and sections.

There are several types of perspectives depending on your orientation and objects in a view. This tool and its activities use a one-point perspective, which means there is only one vanishing point along the horizon line (eye level). This is different from a two- or three-point perspective, where there are multiple vanishing points that correspond with the placement and angle of the objects in the room.

These perspectives involve drawing or envisioning the “construction lines,” the lines that create the perspective or illusion of three-dimensional space. You can use a variety of processes with this – working with room templates that already have the construction lines on them, drawing construction lines on images or photos, or creating one’s own spaces with construction lines from scratch.

Perspective activity

Using the templates and instructions provided, construct a perspective that will look like Figure 5 (on next page). These templates already have some construction lines (the lines that create the perspective or illusion of three-dimensional space) drawn on the plane. If desired, add images to the drawing to make a montage (see Montage handout).

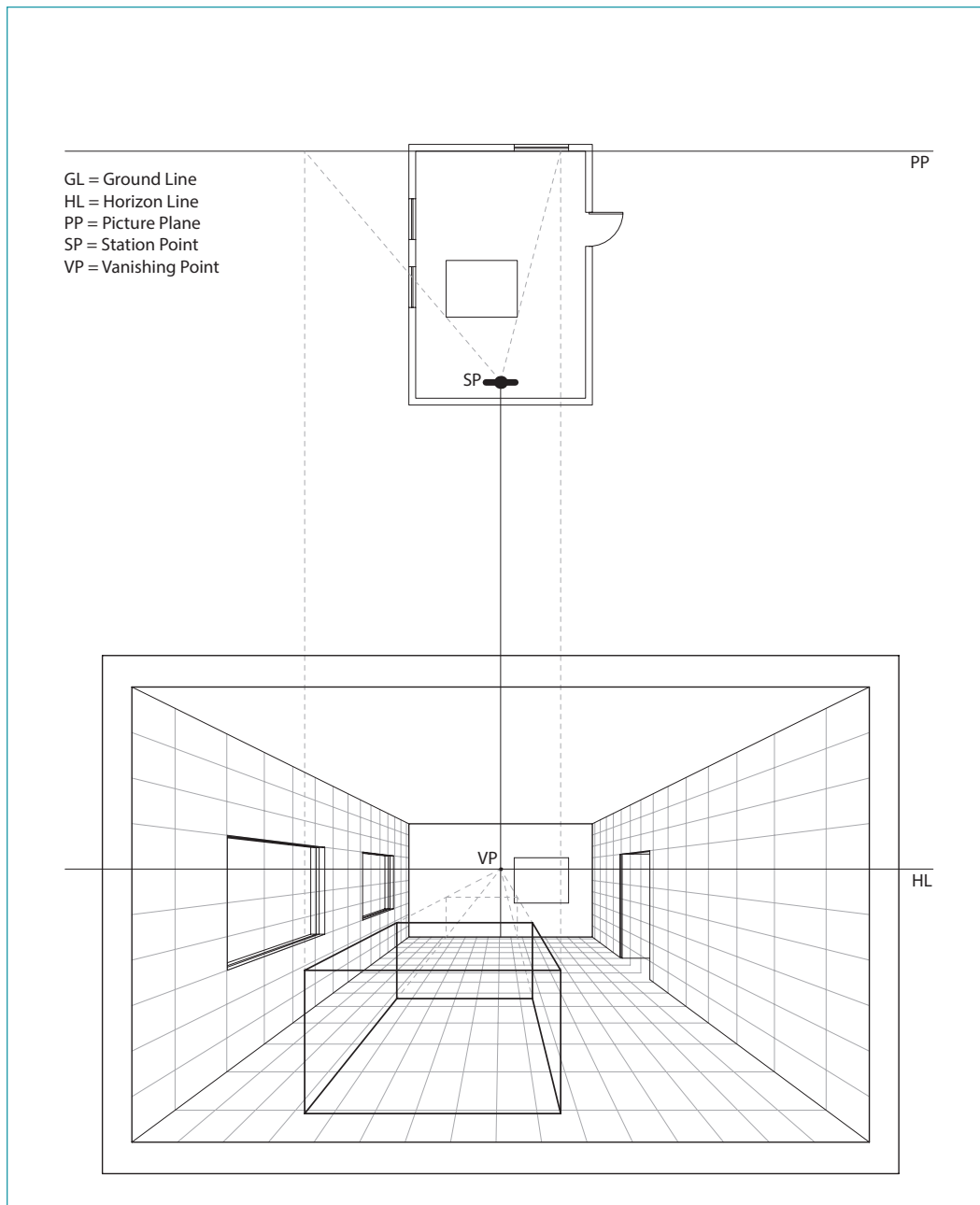

Figure 5

Montage

Another technique that draws on both collages and perspective drawing is montage. Montage combines multiple two-dimensional media (e.g., images from magazines, photographs) to add a richness and depth to a photo or perspective that you have drawn. For example, we can add images from magazines that support the ideas taking shape in our minds. Colored pencils, construction paper, and ink pens can also be used to add detail and color.

Montage activity

Using the perspective you have created or an image of another space, you will create a montage. For this phase of the design, you can use the ruler or scissors to cut out images from magazines. Various pieces of furniture, people, lighting, or plants are great choices. Once you have cut them out, move them around the perspective until they feel like they fit within the image in terms of size. For example, a person should not be a giant in the room. Use your window or door to test this. Next, cutouts of outdoor scenes or sky can be dropped in behind windows to show that there is an environment outside of the room. Finally, you can add color to walls, floors, or ceiling with colored pencils. Pens often overpower the image.

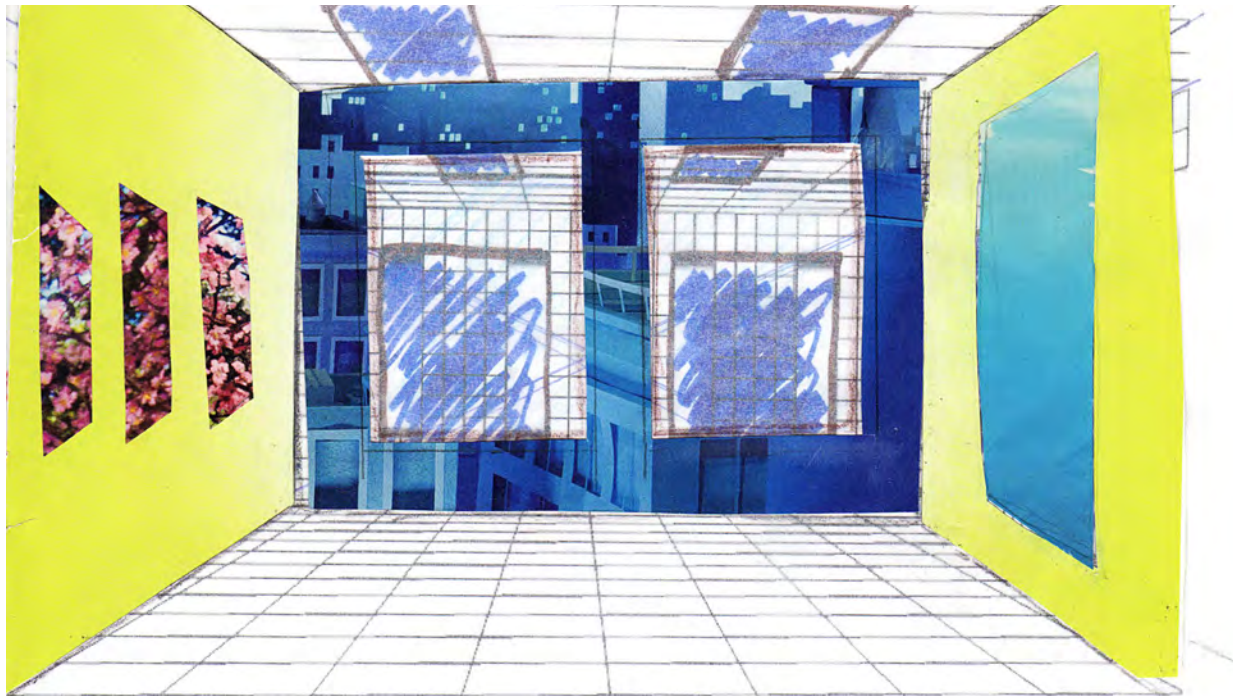



Tool

4

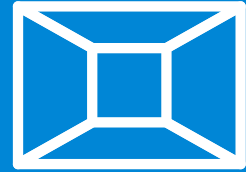

Perspective/
Montages

Templates

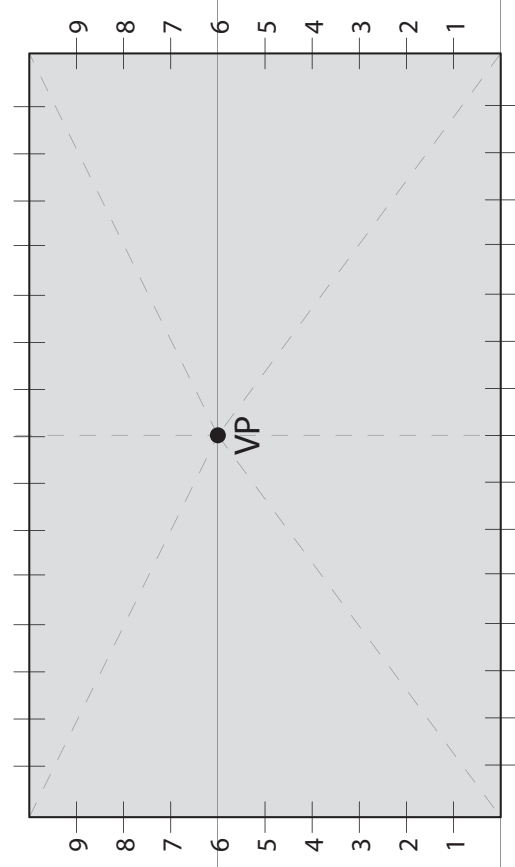

- GL = Ground Line
- HL = Horizon Line
- PP = Picture Plane
- SP = Station Point
- VP = Vanishing Point

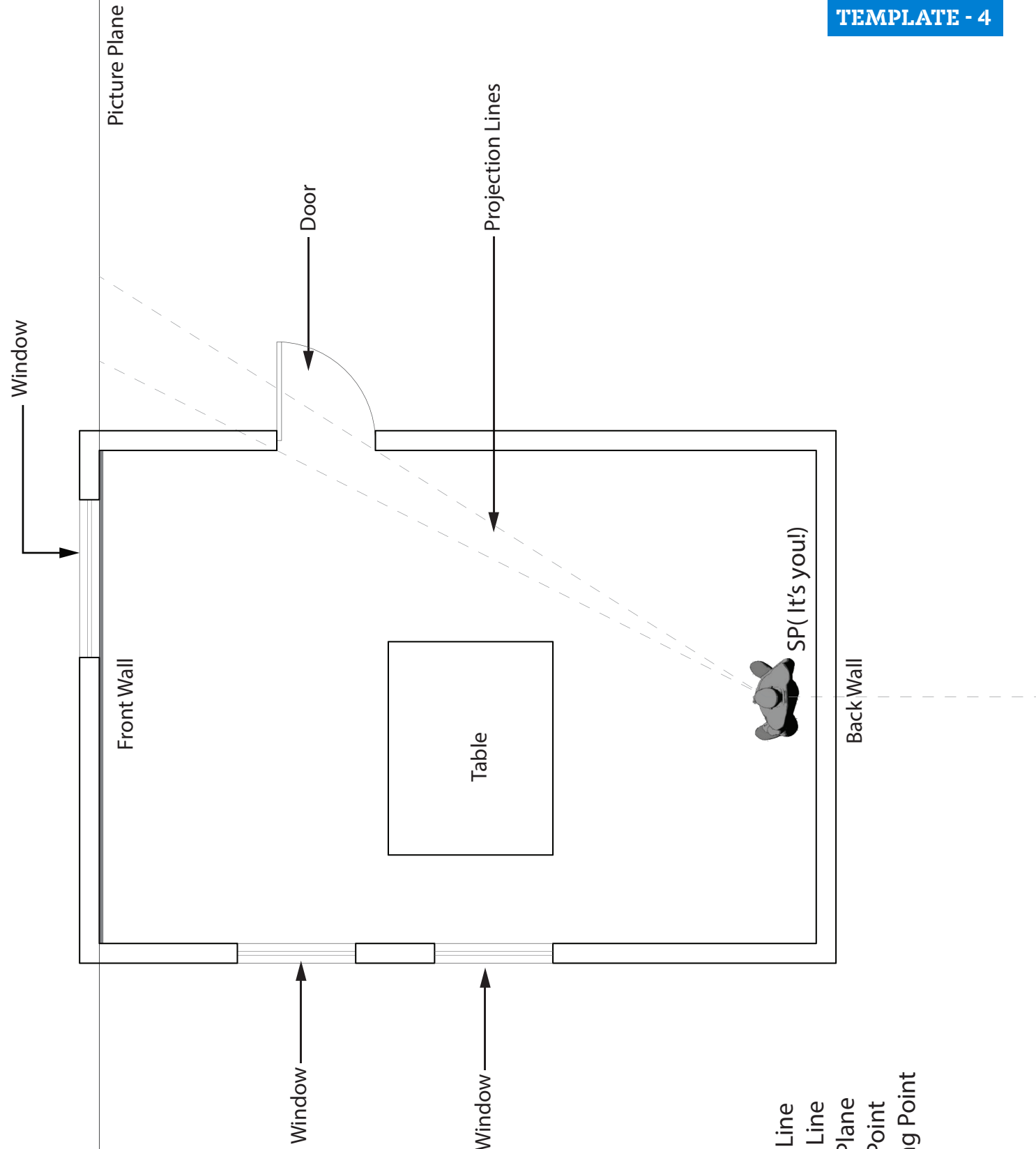

- GL = Ground Line
- HL = Horizon Line
- PP = Picture Plane
- SP = Station Point
- VP = Vanishing Point

Tool 5



Peace & Justice Cards





Description

Peace and Justice Cards

Peace and Justice Cards are a conceptual deck of cards that can be used to explore design ideas with communities across cultures and language barriers. They cover a range of themes including places, people, objects, materials, and textures. By making selections of images in response to prompts and queries, participants can create a photographic essay of the qualities of spaces informed by restorative justice and love. These cards also are an easy way for participants to explore experiences with various emotions.

These can easily be used over and over again and are a cheap, easy, and fast way to elicit insight from participants about the design elements of spaces informed by restorative justice.

It is difficult to have all the potential images that participants may desire. If they do not see a card that represents an essential quality of the space they are considering, they can use pens, markers, and pencils to draw and write on blank cards to add to their deck.





SAMPLE EXERCISE

Divide participants into small groups, give each group a deck of cards, and give them the following prompt:

As a group, select and agree on five cards that represent the qualities of a space that is grounded in love.

Participants may find it helpful to consider the queries below when determining their selections:

- What are the essential qualities that this kind of space would need?
- What images are you drawn to and why?
- What are common themes among the small groups?

Participants then present their selections to the larger group. After each group has presented, facilitate a large group discussion about similar and differing themes and design characteristics across the groups.





Plan and Process

Use this tool to

- Explore metaphors for justice, peace, calm, etc.
- Identify and discuss the design characteristics of spaces designed to facilitate justice, peace, calm, etc.
- Challenge participants to identify and agree on essential design characteristics.
- Identify literal and metaphorical characteristics of buildings, rooms, and spaces.
- Picture the “feel” of a place or space.
- Visualize concepts, ideas, or personal experiences.
- Explore participants understanding and perceptions of themes under discussion.
- Explore a variety of topics where visual imagery may facilitate learning.
- Encourage participation from those who may be less confident in their verbal communication skills.

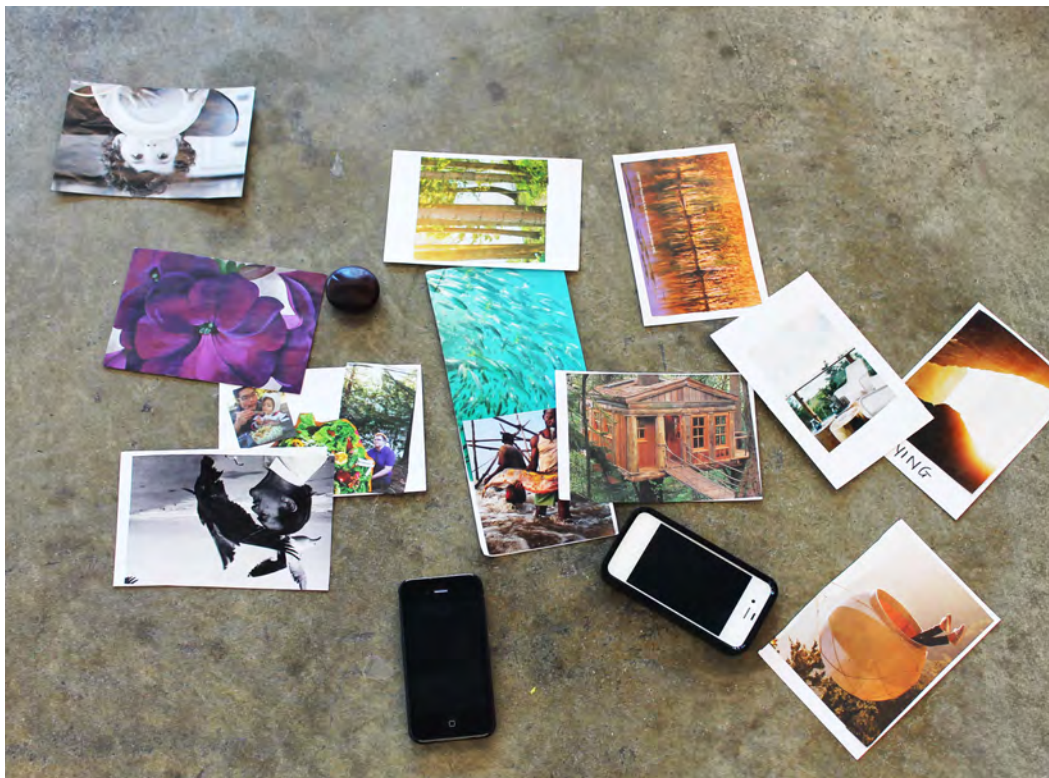



Modify the sample exercise

Prompt 1: As a group, select five cards that represent the qualities of a restorative space.

Prompt 2: As a group, select five cards that represent a space that is peaceful, nourishing, and/or calming.





Exercise 1: The Peacemaking Palette

Traditional Native American peacemaking processes use storytelling from elders to persuade, guide, and heal within a circle formed by the larger community. The peacemaking pallet process draws on this tradition in order to get valuable input from the community on the design of spaces that are intended for restorative justice. Through the use of circles and several prompts, each participant contributes an image that represents his or her individual experience, in response to a prompt.

Invite participants to select an image they feel drawn to from a large pile of pictures (which may or may not be in a card format). This image provides a safe medium for participants to tell a story about their particular contribution to the pallet and the design of spaces that facilitate justice and peace building. A sample prompt to guide people in selecting an image is:

Select an image that represents a space that is peaceful, nourishing, and/or calming? Be prepared to tell a story about why you chose this image.

After participants have selected their images, the circle facilitator opens the circle and introduces the norms for respect in the circle, including the use of a talking piece and how the sharing of experiences will occur. If there is time, the group can establish the norms of respect themselves. See the Make and Build section for resources related to facilitating circle processes.

In the first round of the circle process, students/practitioners give a one- or two-word answer to the question:

What values does our current justice architecture communicate?

For example, participants may suggest majestic, disproportionate, institutional, balancing of scales, accountability, punishment, or intimidating. A second circle round may invite participants to the following question:

How does justice architecture communicate this value?

For example, participants may respond with comments about big entry stairs, large buildings, security, monumental columns, control of visitors' direction or activity, formal courtrooms, chaotic lobby, judge on a higher level than others, and prosecutor and defense having their own sides of the courtroom.

Facilitator then invites the participants, in circle, to present the cards they chose for peaceful, nourishing, and/or calming spaces and tell a story about the image they selected. After each participant shares their story, they place their picture in the middle of the circle to create a peace pallet of stories that represent a collective vision for restorative, peaceful, nurturing, and calming spaces for this particular community.

As a final circle, invite participants to respond to the following question:

What does your image suggest about values that may be essential to the justice process?

After this final prompt, invite the group to respond to the palette and the images included in it. Display the palette throughout the workshop.



Exercise 2: The Peacemaking Palette with objects

If feasible, invite participants to bring personal objects to the workshop that are meaningful to them, using the following prompt:

Select an object you feel drawn to or that represents a place or time in your life that was peaceful, nourishing, and/or calming. Be prepared to tell a story about why you chose this image.

Facilitate the circle similar to Exercise 1 above, using similar prompts throughout.

Let participants know that the objects they contributed will be returned at the end of the workshop, as part of a closing circle. A prompt to guide this closing circle might be:

Reflect on all the objects in the palette and the meanings they hold for other people. As you remove your object from the palette, share one new insight you have gained about spaces that promote peacefulness (or nourishment, calm, etc.) and one new thing you can do with the environments in your life to also experience peacefulness (or nourishment, calm, etc.).

Present and debrief the design tool

Whether using images on cards, loose images, or personal objects, the following questions may be used to discuss and debrief the various activities:

- What are common themes across the images/objects?
- What are differences across the images/objects?
- What is surprising about the images/objects?
- How do you react or respond to these images/objects as representative of a way to do justice that is restorative or aimed at experiences of peacefulness, nourishment, or calm?



Make and Build

Peace and Justice Cards are easy and fun to make with groups of people. This tool provides the practitioner, architect, or researcher with a direct and concise way of getting design input when time is limited. The nice thing about this tool is that once you have a deck of cards, you can use it over and over again.



Materials and process

1. Make your own deck of cards

Collect images from photos, the Internet, or magazines, and cut or fold them to the size of the card on which they will be affixed. Be careful to frame the image the way you want it, prior to cutting or folding. Then glue or tape the image to a blank postcard of any size. You may wish to add questions, words, a stamp, or icon on the opposite side to brand your cards and allow them to be used in a variety of ways.

Materials

- Scissors or chipboard ruler to rip straight edges.
- Glue sticks and/or double sided tape.
- Images/magazines.
- Postcards or simple 3" x 5" or 5" x 7" office cards (a larger card allows for more flexibility).



2. Buy a deck of cards

If you wish to get a deck of cards professionally made, visit the websites below or buy our deck online at www.designingjustice.com/tool/peaceandjustice.

Additional Websites

www.makeplayingcards.com

www.printerstudio.com/unique-ideas/custom-playing-cards

3. Create cards using the *DJ+DS* template

Template 5 in this section includes a selection of images that you can use, as well as some blank cards for you to create your own deck of cards. These images can be pasted onto 5" x 7" cards, available at any office supply store, if you want them to last longer.

Materials

- Scissors or chipboard ruler to rip straight edges.
- Glue sticks and/or double sided tape.
- 5" x 7" postcards.

Peacemaking references

For more information on circles processes or Native American approaches to justice and peace-building, see the following resources:

- *Peacemaking Circles: From Crime to Community* by Kay Pranis, Mark Wedge, and Barry Stuart.
- *Little Book of Circle Processes* by Kay Pranis.



Peace & Justice Cards

 Designing
Justice+Designing
Spaces



Tool
5



Peace & Justice
Cards

Participant Handout



Peace and Justice Cards

Peace and Justice Cards are a conceptual deck of cards that can be used to explore design ideas with communities across cultures and language barriers. They cover a range of themes including places, people, objects, materials, and textures. By making selections of images in response to prompts and queries, you can create a photographic essay of the qualities of spaces informed by restorative justice and love. These cards also are an easy way for you to explore experiences with various emotions.

It is difficult to have all the potential images that everyone may desire. If you do not see a card that represents an essential quality of the space you are considering, you can use pens, markers, and pencils to draw and write on blank cards and add to your deck.

Peace and Justice Cards activity

In your small groups, consider the following prompt:

As a group, select and agree on five cards that represent the qualities of a space that is grounded in love.

You may find it helpful to consider the questions below when determining your selections:

- What are the essential qualities that this kind of space would need?
- What images are you drawn to and why?
- What are common themes among the small groups?

You will present your selections to the larger group. After each group has presented, you will participate in a large group discussion about similar and differing themes and design characteristics across the groups.



Tool
5



Peace & Justice
Cards

Templates

Cut these out



Cut these out



Cut these out



Cut these out



Cut these out

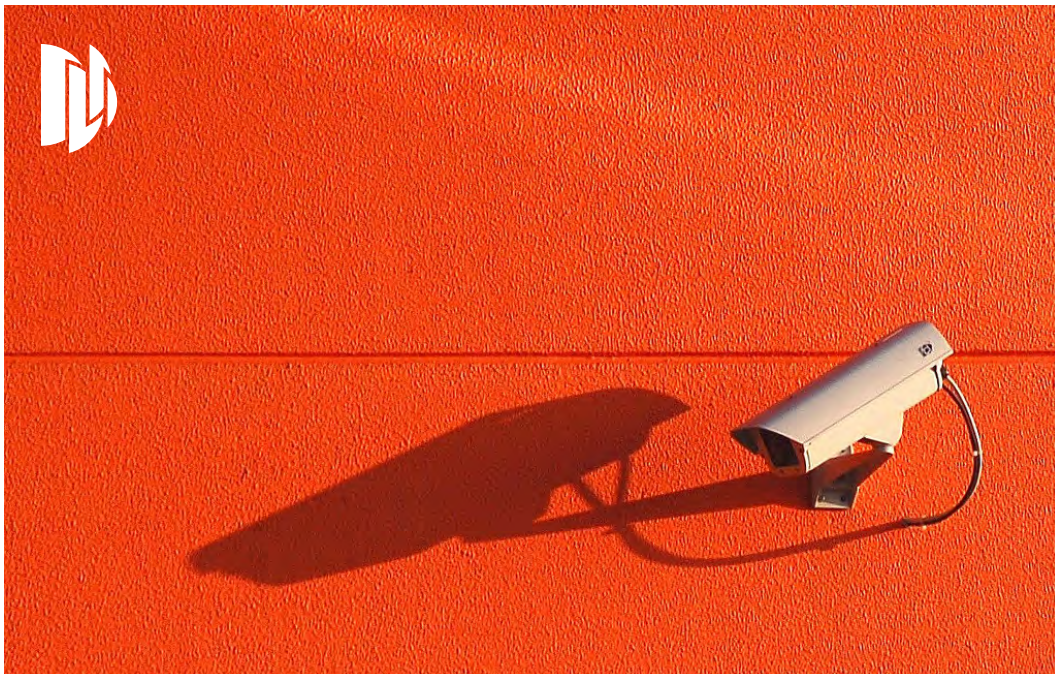

Cut these out

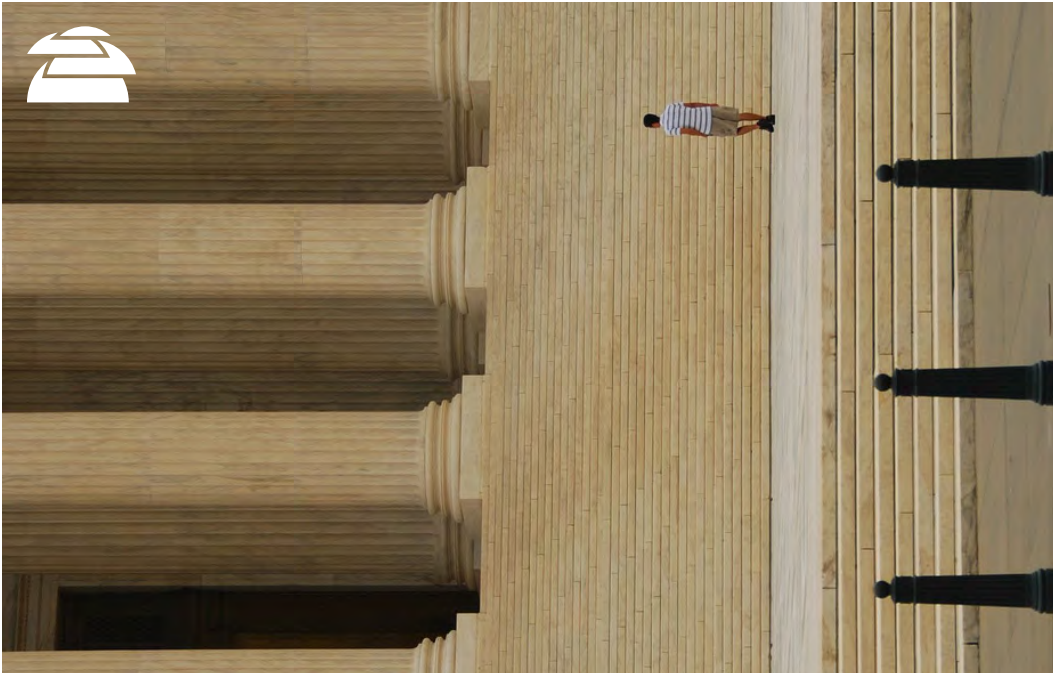

Cut these out



Cut these out

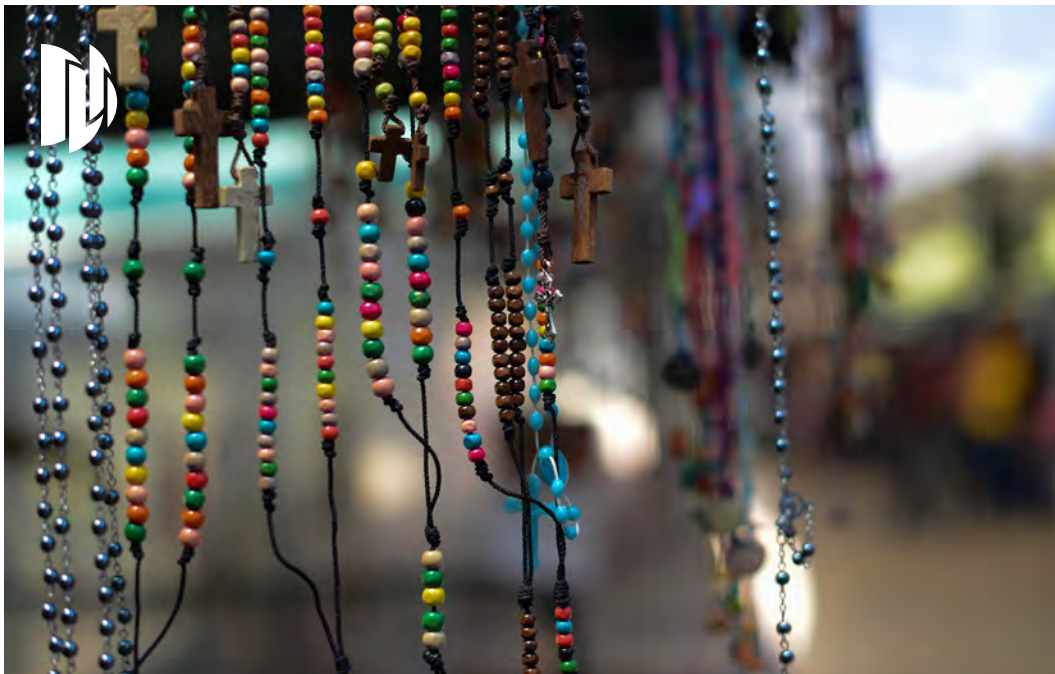

Cut these out



Cut these out



Cut these out



Cut these out



Cut these out

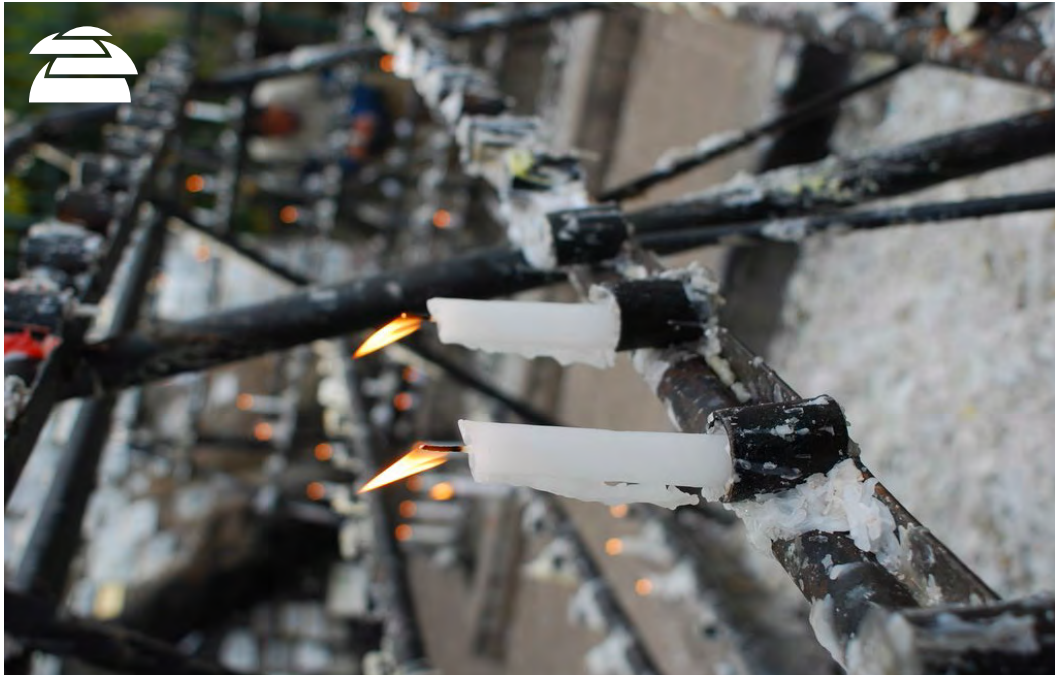

Cut these out



Cut these out



Cut these out

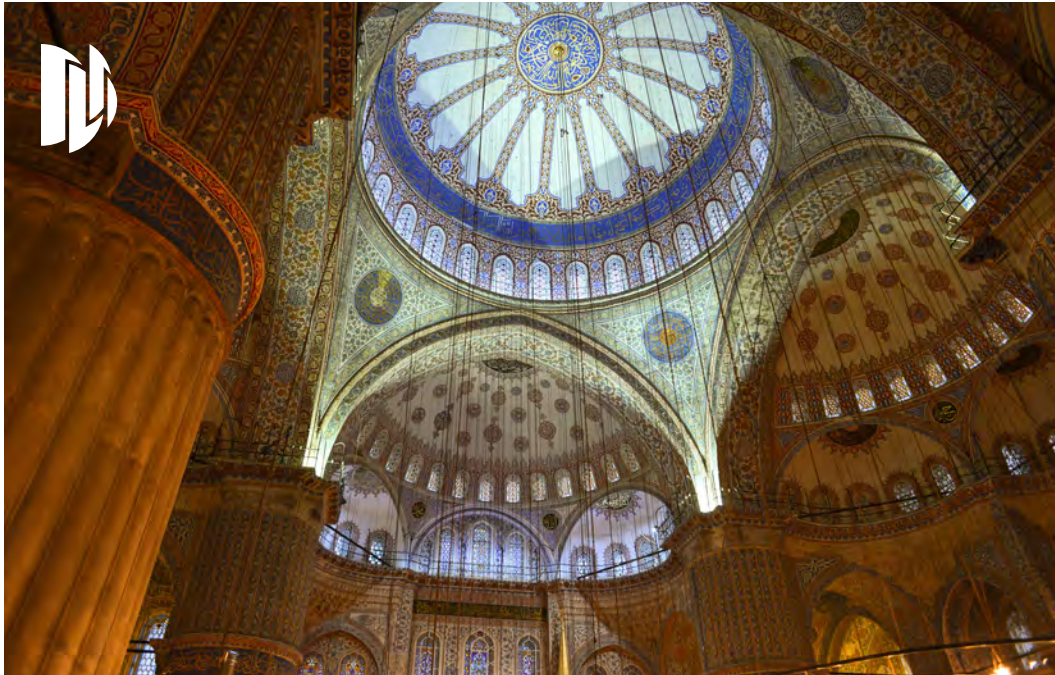

Cut these out



Cut these out



Cut these out



Cut these out



Cut these out



Cut these out

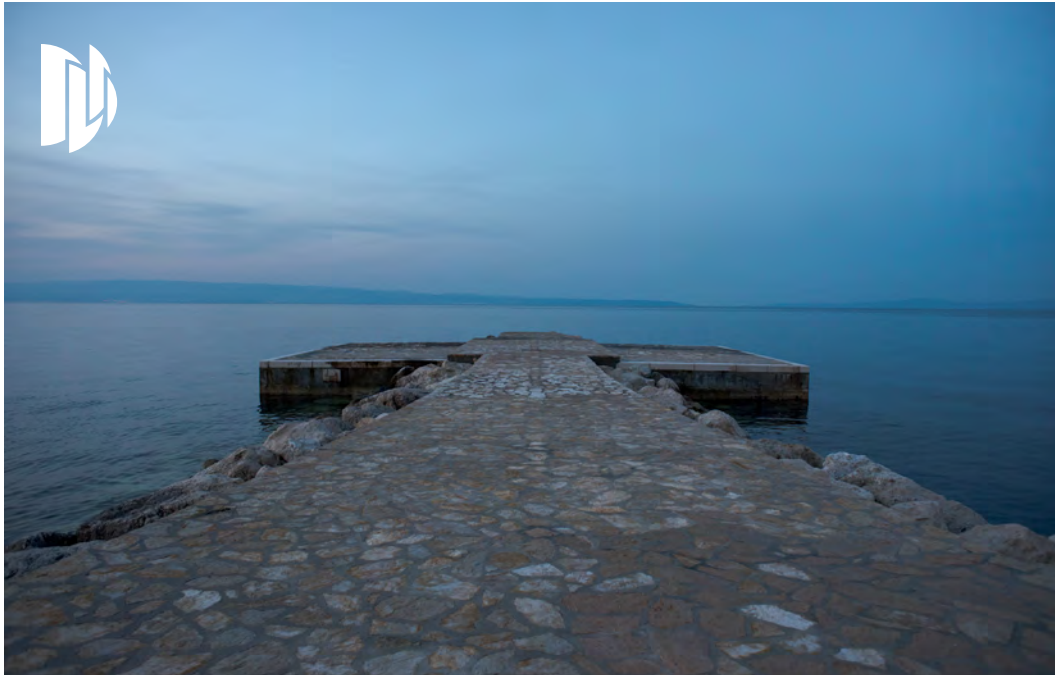

Cut these out



Cut these out



Cut these out



Cut these out



Cut these out



Cut these out



Cut these out



Cut these out



Cut these out



Cut these out



Cut these out



Cut these out



Cut these out



Cut these out



Cut these out



Cut these out



Cut these out



Cut these out



Cut these out



Cut these out



Cut these out

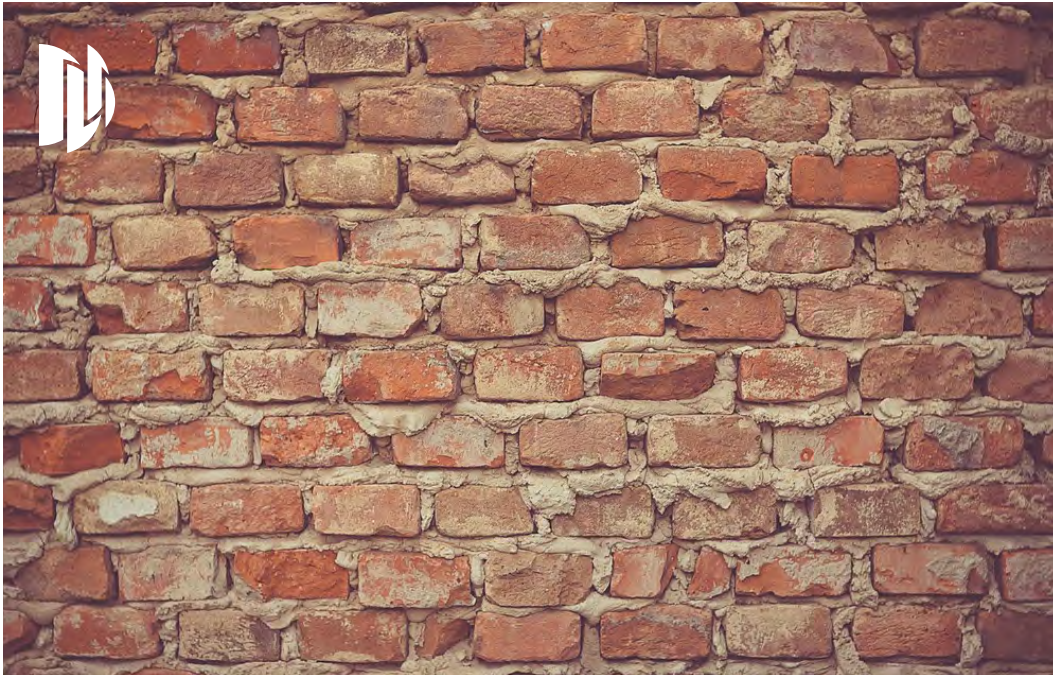

Cut these out



Cut these out



Cut these out



Cut these out



Cut these out



Cut these out



Cut these out



Cut these out



Cut these out



Cut these out

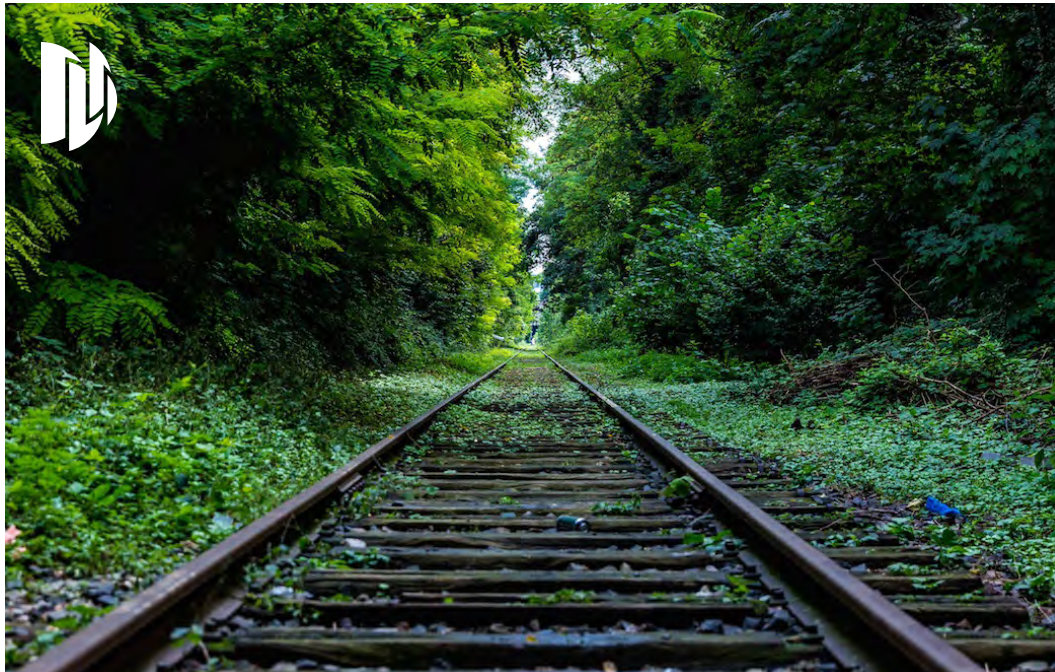

Tool
6

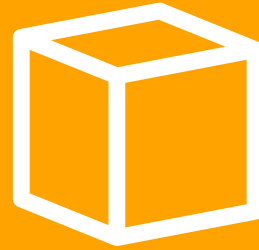

**Model Making
with Blocks**





Description

Model Making with Blocks

Model making with blocks is, perhaps, the easiest way for participants to explore three-dimensional space in the toolkit. This tool provides a familiar and hands-on way for participants to express thoughts about space and provide creative and emotional input by using three-dimensional objects.

Blocks may not be allowed into all institutions but, if they are, they can help you quickly explore ideas at the scale of a room or building and without a lot of mess. This section explores various ways to use and create a set of blocks yourself.

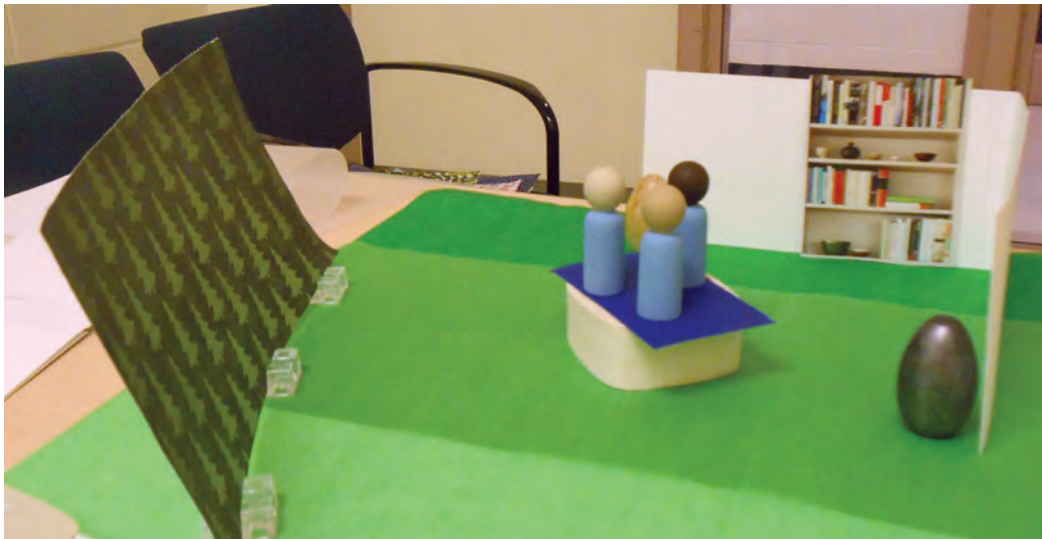

SAMPLE EXERCISE

On a table, set out a collection of blocks of various shapes and sizes, as well as a selection of paper of various types, markers, and other design supplies. Invite participants (individually or in small groups) to create a scene, building, room, or landscape that is based on love or restoration, using the blocks and other materials. After they have completed their designs, each participant or group of participants presents their design to the rest of the group, explaining its characteristics and their relationship to restoration. Facilitate a large group discussion that invites participants to explore similarities and differences across their designs.



Plan and Process

Use this tool to:

- Explore space layouts.
- Easily visualize concepts and ideas for three-dimensional building designs.
- Identify and discuss the design characteristics, spatial relationships, and functions of spaces designed to facilitate justice, peace, calm, etc.
- Create and build physical spaces for justice, peace, engagement, reflection, etc.
- Challenge participants to identify and agree on essential design characteristics and spatial relationships.
- Translate the “feel” of a space into a built form.
- Visualize concepts, ideas, or personal experiences.
- Explore participants understanding and perceptions of themes under discussion.
- Encourage participation from those who may be less confident in their verbal communication skills.





Modify the sample exercise

Exercise 1: New justice architecture

On a table, set out a collection of blocks of various shapes and sizes, as well as a selection of paper of various types, markers, and other design supplies. Explain to participants that they will use the blocks to develop a design for a new kind of justice building that fosters love and forgiveness.

Divide the group into three small groups. Each group represents either victims, offenders, or community. Provide each group with a set of blocks. Ask each participant to create a narrative about their experience coming to this new building and consider the spaces that would need to be represented in their designs. For instance:

1. What is the first space you would enter?
2. How should the entry space look and feel?
3. In what order would someone go through the rooms?
4. What rooms should be adjacent to each other?
5. What spaces might be upstairs or downstairs?
6. Are there spaces not represented here? If so, make new spaces to accommodate the needs of your group.

After each group has had thirty minutes to create their ideal spatial organization and building, each group presents their designs. Facilitate a large group discussion about the similarities and differences across the space and room arrangements, across the three groups.

Present, debrief or analyze the design tool

The following prompts are helpful for exploring design characteristics and the rationale behind them:

- What are common themes across the designs?
- What are differences across the designs, based on whether your group designed for a victim, offender, or community member?
- What is surprising about the choice of spaces and their relationships to one another?
- How can this inform the design of our current justice architecture?



Make and Build

There are several ways to make and build this toolkit. The sections below describe the options at your disposal and processes to use to get a toolkit you can use within most institutions.



Materials and process

1. Off-the-shelf block kit

Create a collection of wood or foam blocks and/or paper band boxes in various sizes and shapes. The materials below can be found at most arts and crafts stores. You can apply colored paint to these blocks to identify the different rooms.

Materials

- Cubes – 1 ¾", 1 ½", and 1 ¼".
- Circles – 2 ½" and 2".
- Egg – 2 ½" and 2".
- Square band boxes – 3" and 2".
- Round band boxes – 3" and 2".
- Paint (if desire to label blocks).



2. Make it yourself, by hand

If you are crafty and would like to make your own blocks, you can use standard wood shop machines to cut the blocks out of wood. Below is a list of suggested block sizes. You can apply colored paint to identify the different rooms or laser cut titles/symbols into them for clarification.

Block	Amount	Length	Width	Height
Indoor Spaces				
Large Square	2	17/8"	17/8"	11/2"
Large Circle	2	17/8"		11/2"
Small Square	2	11/4" diameter	11/4"	11/2"
Small Circle	2	11/4" diameter		11/2"
Private Rooms	4	3/4"	3/4"	3/4"
Entry Space	2	21/8"	11/2"	11/2"
Large Multi Purpose	2	21/8"	11/2"	3/4"
Small Multi Purpose	2	11/2"	11/8"	3/4"
Family Room	4	1"	1"	3/4"
Children's Space	1	11/2"	11/8"	3/4"
Kitchen/Dining	1	21/2"	21/2"	3/4"
Stairs	2	11/8"	5/8"	11/2"
Elevators	2	7/8"	3/8"	11/2"
Bathrooms	2	11/8"	3/4"	3/4"
Short Corridor	2	11/2"	3/8"	3/4"
Long Corridor	2	27/8"	3/8"	3/4"
Outdoor Spaces				
Green Space/Gardens	4	13/4"	13/4"	1/16"
Recreation Space	1	21/2"	21/2"	1/16"
Large Water Circle	2	15/8" diameter		1/16"
Small Water Circle	2	7/8" diameter		1/16"

Materials

- 3/4" Bamboo plywood or 3/4" high grade plywood or bass wood.
- Table saw or band saw.
- Laser cutter.
- Paint (if desire to label blocks).



3. Make it yourself, digital

If you are a lover of all things digital and would like to make this kit yourself, you can find on our website Rhino files with the blocks we use in our kit that can be easily 3-D printed. You can have these done locally but you will need to look up vendors in your area who do this. This is helpful if you want to have a chat about color, materials, and how to cut costs. A second option is to go through an online vendor who will ship your blocks to you once you get them the files. Be sure to get a quote first and know your material options.

References

- i.materialise: i.materialise.com/
- Shapeways: www.shapeways.com/
- Sculpteo: www.sculpteo.com/

Tool
6



Model Making
with Blocks

Tool
6



**Model Making
with Blocks**

Participant Handout

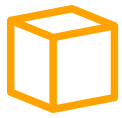

Model Making with Blocks

Model making with blocks is, perhaps, the easiest way to explore three-dimensional design. This tool provides a familiar and hands-on way for you to express thoughts about space and provide creative and emotional input by using three-dimensional objects.

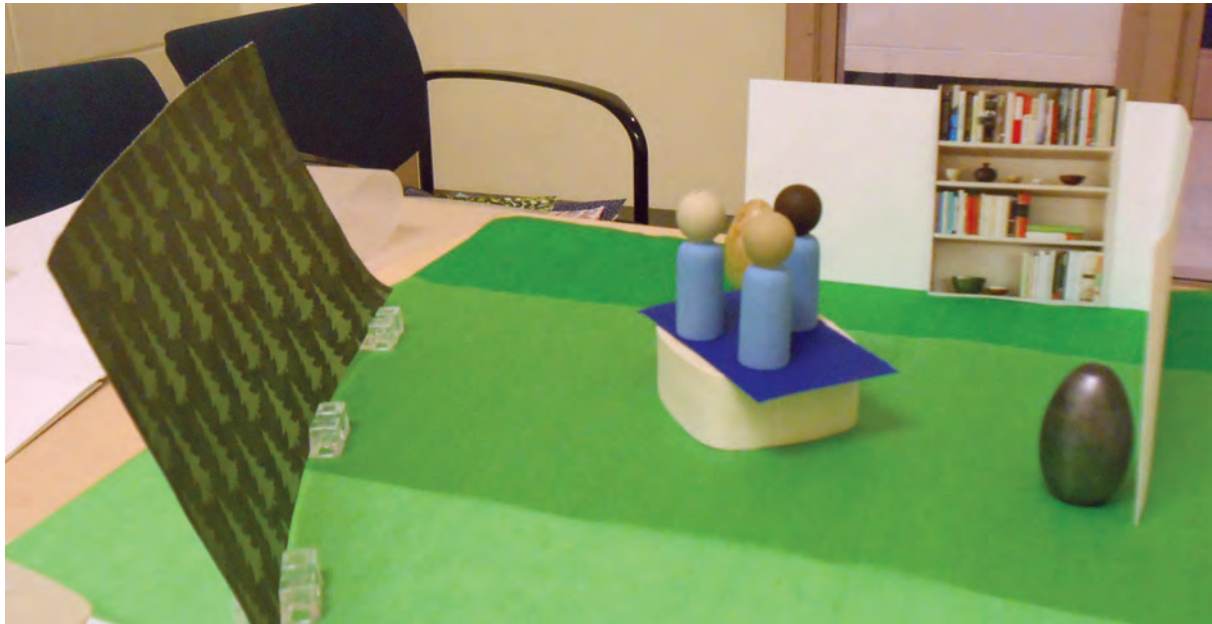

Model Making Exercise

On a table, you will see a collection of blocks of various shapes and sizes, as well as a variety of paper, markers, and other design supplies. You will use these materials to create a scene, building, room, or landscape that is based on love or restoration. After you have completed your design, you will present it to the rest of the group, explaining its characteristics and their relationship to restoration. As a large group, you will explore similarities and differences across your designs.

Tool
6

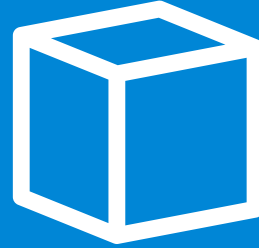

**Model Making
with Blocks**

Templates

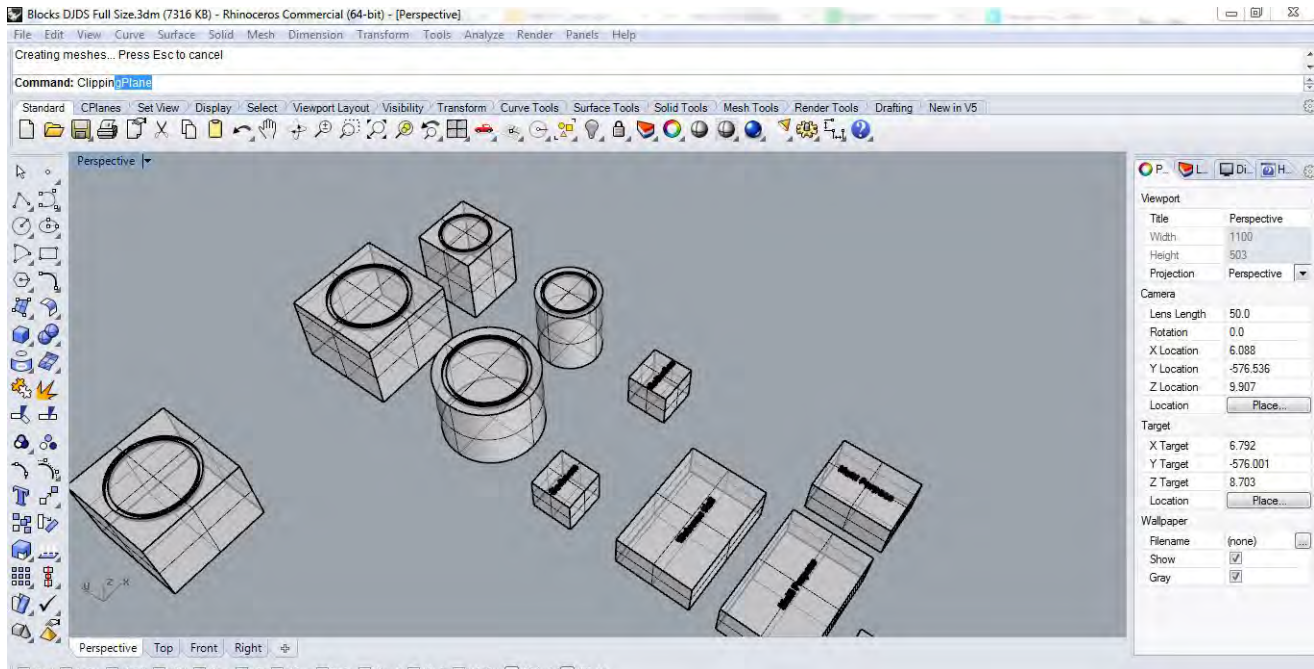

This template is in a digital format as an AutoCad or Rhino file and can be downloaded from our website here.



Tool
7



Model Making
with Paper

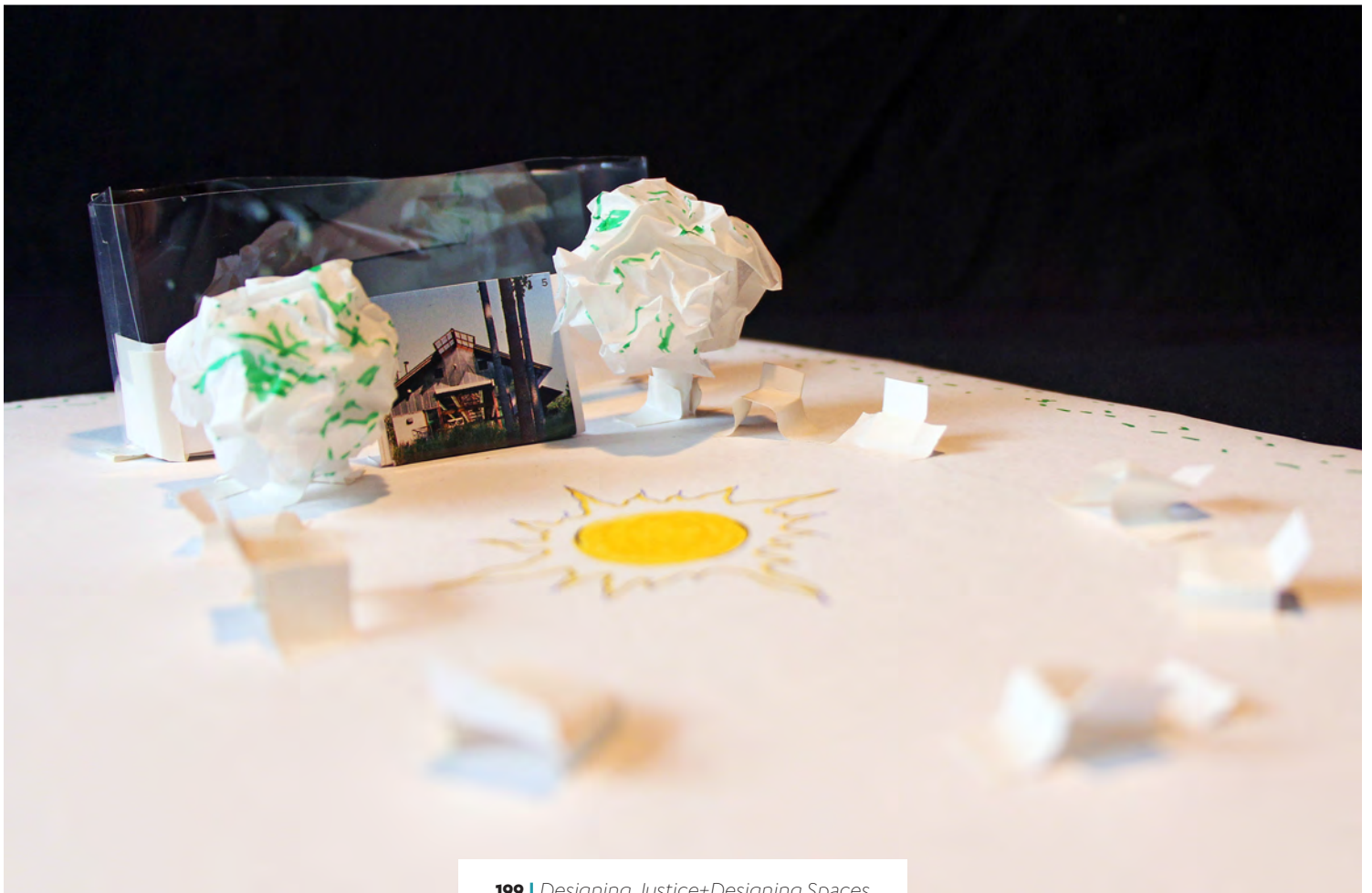



Description

Model Making with Paper

Like model making with blocks, model making with paper provides a hands-on way for participants to express thoughts about space and provide creative and emotional input. This time, however, participants use material techniques, rather than pre-made objects. As a result, these basic paper model-making materials provide more of a blank canvas upon which participants can imprint their unique view of the world. For example, ripping, doing rubbings, and folding and scrunching paper, chip board, acetate, or vellum can provide participants with greater flexibility in creating ideas about how space can be designed for refuge, privacy, or security.

Allowing participants to draw from memory or cut images from magazines of trees or flowers and paste them on to chipboard or paper means they have a much greater range of expression, as you could never provide every kind of plant or animal. It also helps to develop a sense of scale, which is a hard concept to teach to those unfamiliar with representing ideas about space.



SAMPLE EXERCISE

As folding paper is a basic technique for the creation of a paper model, a good first exercise for participants is to make a simple box house. Template 7 is a template for such a house and instructions for working with the template are provided in the Make and Build section. By using this template with a chip board base, participants can practice this paper folding technique.

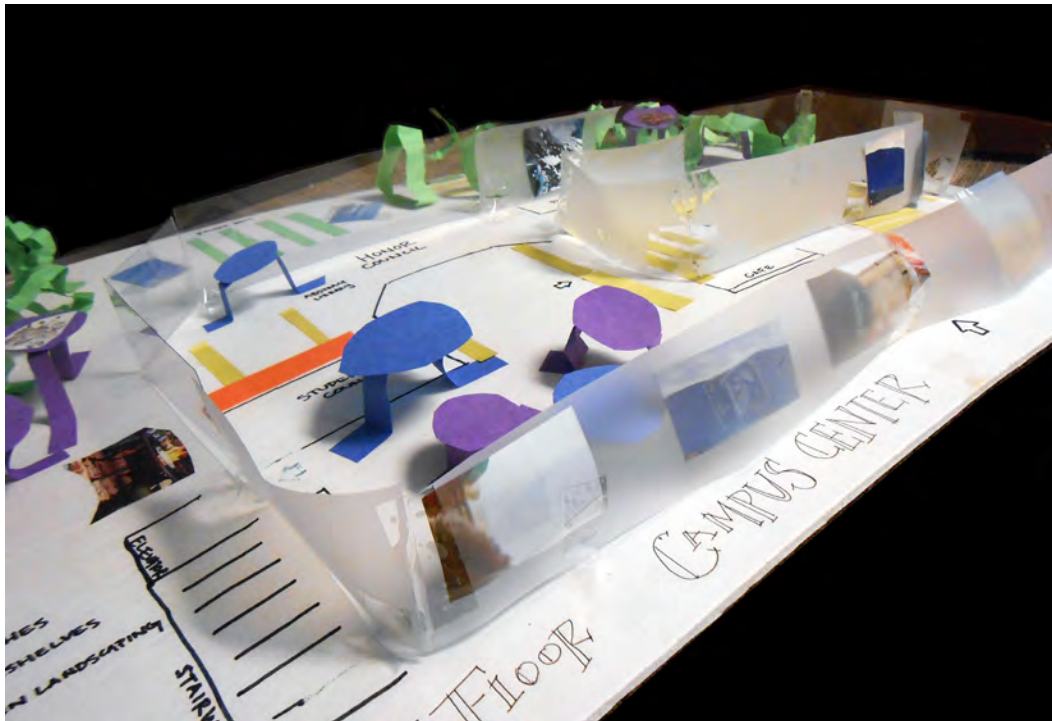



Plan and Process

Use this tool to:

- Explore space layouts.
- Easily visualize concepts and ideas for three-dimensional building designs.
- Identify and discuss the design characteristics, spatial relationships, and functions of spaces designed to facilitate justice, peace, calm, etc.
- Create and build physical spaces for justice, peace, engagement, reflection, etc.
- Challenge participants to identify and agree on essential design characteristics and spatial relationships.
- Translate the “feel” of a space into a built form.
- Visualize concepts, ideas, or personal experiences.
- Explore participants’ understandings and perceptions of themes under discussion.
- Encourage participation from those who may be less confident in their verbal communication skills.



Modify the sample exercise

Exercise 1: Re-envisioning an existing place

In this exercise, best suited as a follow up to the sample exercise, students create unique models using the collection of supplies and instructions outlined in the Make and Build section. Students may create models of existing justice spaces of either 1) their choice or 2) in response to a prompt provided by the instructor. Sample prompts may be:

- Re-envision the courtroom design using restorative justice values.
- Remodel the visitor waiting area to support healing and nourishment.
- Select a room in your current environment and redesign it to reflect restorative justice values.

Participants may work individually or in groups to create their model. In addition to physical and built spaces, students are encouraged to also include doors/windows, nature, people, furniture, etc. As they build, they will want to consider the following:

- What functions does the space(s) perform, or could offer?
- How do the different spaces in the model relate to each other?
- How do people relate to each other and move through the space?

As participants are working on their models, do an occasional “desk crit” (or desk critique) to assist them in pushing out their ideas and to promote creativity. Bring a marker and paper with you, so you can sketch ideas that surface during your conversation.

Students will then present their models to the large group.

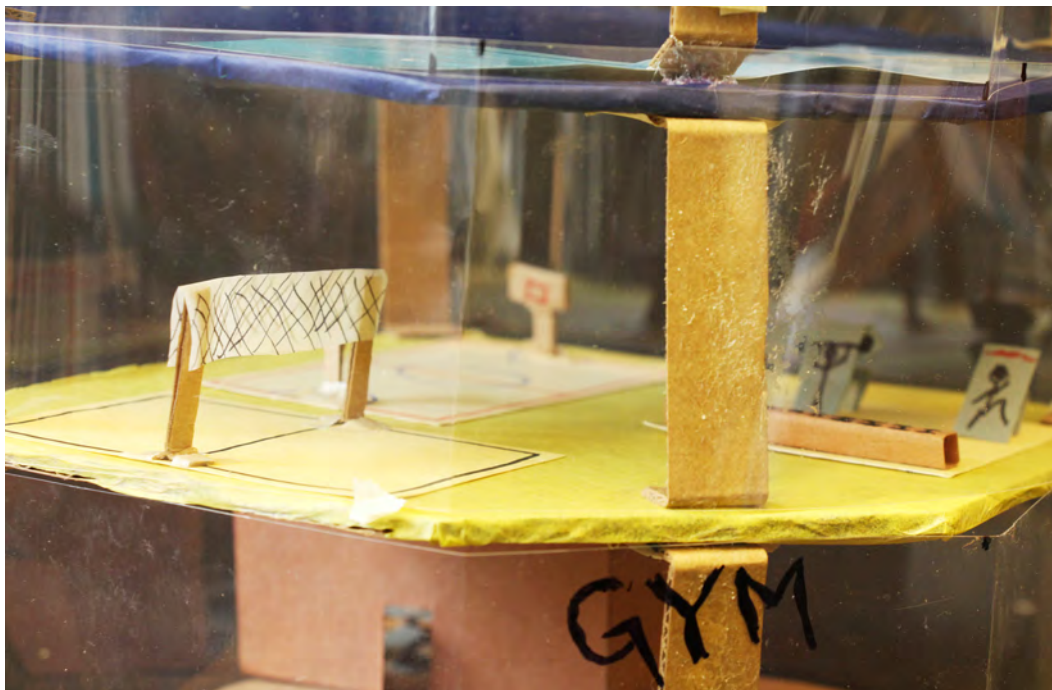

Exercise 2: Creating a new space

Inviting participants to envision a completely new space, building, or collection of rooms that represents architecture based on restorative justice, love, and other restorative values is an exciting approach that often yields the most creative results. With this exercise, participants respond to a prompt by creating their own building or room from scratch that may have never existed before. Participants can explore their design concept in any way they like. It can be one room from a larger design concept or the entire project. Sample prompts include:

- Create a model of a courthouse design that has been designed using restorative justice values.
- Create a model of a space in which a victim offender dialogue could occur.
- Create a model of a building that supports accountability and forgiveness.

As in the first modified exercise above, participants may work individually or in groups to create their model. Facilitators should encourage participants to represent all the important ideas in their model. Furniture, trees, or other special features can be created using magazine images, drawing on paper, or folding the paper to create the desired element. As they build, participants will want to consider the following:

- What activities occur in the space?
- How do the different spaces in the model relate to each other?
- How do people relate to each other and move through the space(s)?

As participants are working on their models, do an occasional “desk crit” (or desk critique) to assist them in pushing out their ideas and promoting creativity. Bring a marker and paper with you so you can sketch ideas that surface during your conversation.

Participants will then present their models to the large group.



Present and debrief the design tool

Upon the completion of the model-making process, facilitate a large group discussion. Some sample questions include:

- In what ways are restorative values embodied in the models?
- What are common themes across the models?
- What are differences across models?
- What is surprising about the models?





Make and Build

Model making is one of the most challenging tools to use inside a correctional facility but may be one of the most rewarding as participants get a chance to be physically engaged with the tools and to create a three-dimensional representation of their ideas.

These are rough models and are not intended to be well crafted. In addition to using paper to create walls and structures, participants can scrunch the paper to get textures or interesting volumes. They can tape or glue down strips of paper on two ends to get arches. Magazines and printed/texture paper can be added to the model. Trace or velum can be scrunched up for tree canopies, affixed to the top of rolled up paper to be a trunk, and added to the model as natural features. Any way that participants want to manipulate the paper to convey their design is appropriate.

Those inside correctional facilities are typically incredible improvisors, given their limited access to common resources. Their creativity in exploring these materials should be encouraged. These kinds of “messy” models are often used by architects to investigate ideas in an office setting and, with slight modifications, can also be used inside the institution.



Materials

- Two-ply chipboard ruler and triangle (Template 1): This is helpful for ripping paper along an edge or creating straight lines while drafting the outlines of windows and doors onto the paper.
- Pencils/pens: These are used for drawing on the model and for carving into paper, if necessary, for cut out windows, and other openings.
- Magazines, textured, colored, or printed paper, and any other interesting papers that you find and can bring into the institution that are helpful in expressing design intent.
- Single- and/or double-sided tape and/or glue sticks (if using tape, double-sided tape makes a cleaner model).
- Scissors (if permitted) or pre-cut strips of paper (see below regarding bristol board, vellum/mylar, and acetate).
- Chipboard, two-ply: Chipboard serves as the base of the model to which walls and other elements are attached, as described in the exercises.
- Papers:
 - You will want various types of papers so you have solid, clear, and translucent surfaces that can better express students' ideas. These can be pre-cut to the height you would like walls to be in order to make it easier to work with in prison and jail settings.
 - Bristol Board, 85 lb – 24" x 36" sheets or 18" x 24" pads of mix media paper: This can be used to represent elements that are solid or textured. It may come in the form of a booklet or large sheets, which can be cut into strips according to scale.
 - Vellum (paper-like) or Mylar (plastic-like): This translucent material can be used to represent elements that are translucent, such as frosted glass, and can be used to explore themes of privacy and visibility. It may come in the form of a booklet or large sheets, which can be cut into strips according to scale.
 - Acetate: This is a clear plastic-like material that can be used to create windows and other see-through spaces. It may come in 8.5" X 11" or larger sheets and be cut down into strips according to scale.

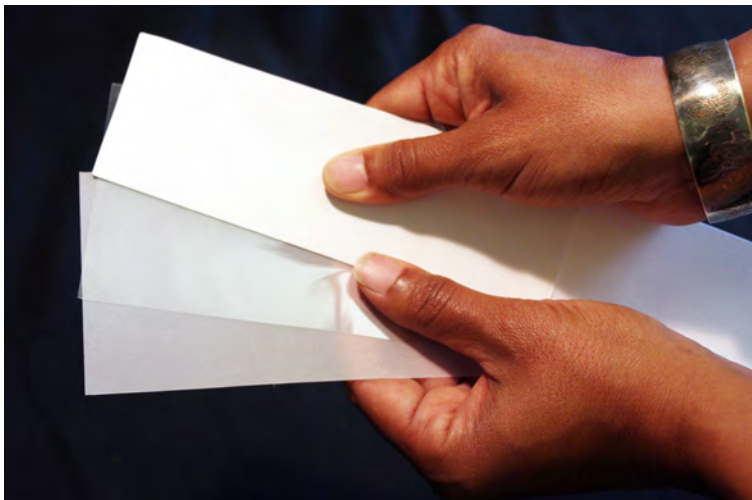

Process

SAMPLE EXERCISE

1. Print out a copy of Template 7 onto thick construction paper or 50 lb card stock, both of which are available at any office or art/craft supply store. The paper just needs to be thick enough to hold its form once folded.
2. Using chipboard, cut out a model base that is sized to the small square on Template 7. This will serve as the base for the house.
3. Participants will cut or tear out the two-dimensional form of the house and the small square (which serves as the base) using scissors or the chipboard rulers from Template 1. To save time, this template can be pre-cut.
4. Once participants have the basic flat form of the house cut out, they fold the house along the solid lines.
5. Once the house is loosely folded, they glue or tape the chipboard base in the center forming the floor of the house. Participants can glue the floor of the house on the base.
6. Participants then attach the walls to form the house. They do this by folding down and overlapping the tabs on the adjacent walls and then attaching them to another using double-sided tape or glue.
7. Participants finally fold down the roof of the box and tape it to the side wall. They should now have a completed little house.

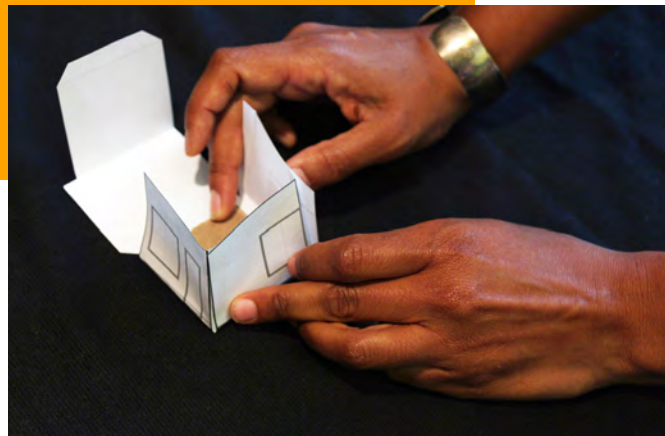
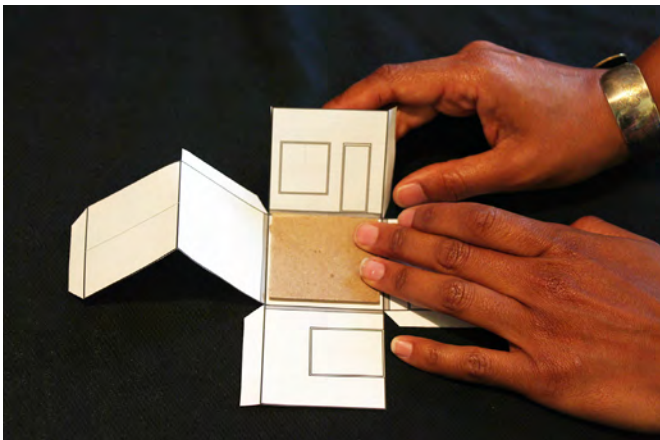

Exercise 1: Re-envisioning an existing space

For this exercise, as you will be creating a floor plan and walls, it is easiest to create models that represent a collection of rooms to a scale of $1/8''$ or $1/4''$ per foot.

1. Before you can re-model an existing space, you must choose the room/space you want to model and make sure to prepare base materials, such as a chipboard outline of the floor plan. Because you are not likely going to have access to photos of the space or a tape measure, if inside a correctional facility, you will need to pace out, or walk, the space to get its dimensions. This process has an advantage over just a photograph as you can get estimates of the measurements needed for building the model. Follow the process for pacing out a space found in the Perspective/Montage Make and Build section.
2. Outline the floor plan of the space (by hand or on a computer), using the measurements you paced out. Make enough copies for each participant and glue down the plan onto the chipboard base. You can either cut around the floor plan to create a profile of the room or you can just leave the chipboard as is, with the plan in the middle. When the chipboard is not cut to exact dimensions of the floor plan, participants can use the extra areas outside the floor plan to add adjacent or support spaces.
3. It is helpful to cut into strips, either before class or in class if scissors are permitted, each sheet of paper you would like to use to form the space. These strips are cut to the height at the scale to which you are working. If using a scale of $1/8''$ or $1/4''$ per foot, a typical 8 ft ceiling height would be represented by a 1" or 2" strip of any material. We also recommend creating additional strips of varying widths that can suggest a difference in height or can be used as other elements in the building, such as low walls, ceiling, roofs, and screens.
4. In the absence of knives or metal rulers, the usual tools of architects/designers, participants fold and rip paper to create their models. Like with the box model in the sample exercises, participants fold the paper where you want a wall to end and continue to fold it along the perimeter to enclose the space. They can also create a sharp crease and tear the paper at the corners to create separate wall planes. It is helpful if, while creating these walls, participants create tabs on the bottom of the walls, which they can later use to tape/glue the wall to the base.
5. At this point, prior to gluing/taping the model components into place, participants also sketch out where they want such features as windows and door openings. Once these are sketched onto the paper, participants tear or cut out these elements of the façade. For example, to cut out a window, participants fold the paper along the center line of the window and tear or cut the paper where they want the top and bottom to be. One of our participants also used the end of his pen to deeply carve out, or perforate, the edges of his windows and doors, which proved to be a very good technique. This same process can be used for the acetate and vellum strips as well.

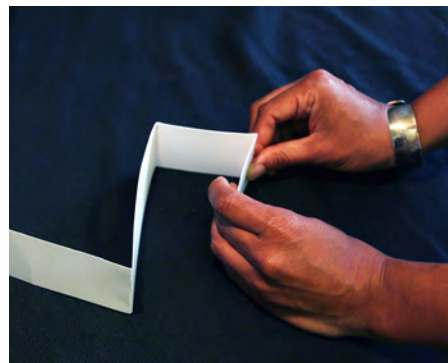

6. Once this is done, participants use double-sided tape or glue to attach the model surfaces to the chipboard. This is most easily done if one has created a tab at the bottom of the wall that can be attached to the base. If not one can attach them with tape at the corners.
7. In this final stage, participants can add a roof or ceiling plans and images from magazines to represent features in the space such as people, planting, and furniture, or other three-dimensional elements of the space.

Exercise 2: Creating a new space

Preparation for this exercise for this process is less arduous than re-envisioning an existing space, as you do not need to create a specific floor plan on which to work.

1. Bring to the session precut walls (1" to 2" high is recommended) as well as additional sheets of paper (8.5" x 11", 11" x 17", or 18" x 24") that can be cut down inside the institution. Also bring precut chipboard bases (11" x 17" is a good size), on which participants will build their models. Two such pieces of chipboard per group will allow them to use them individually or combine them for a larger project.
2. Follow steps 4 through 7 from Exercise 1 above.

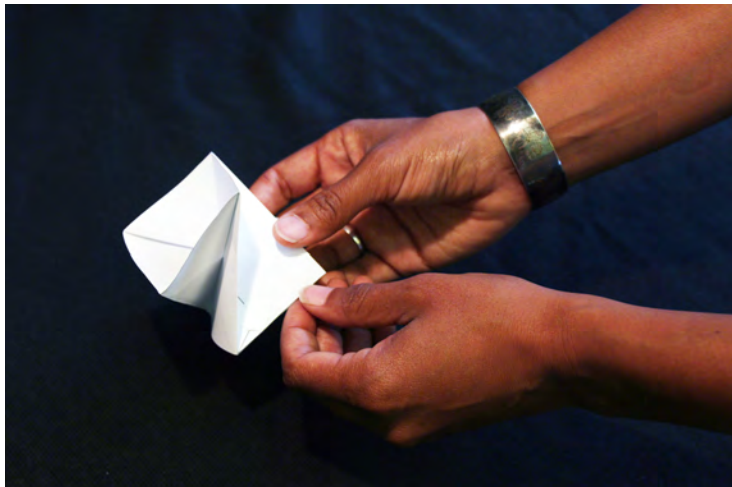

References

- The Paper Architect: Fold-It-Yourself Buildings and Structures by Marivi Garrido and Ingrid Siliakus.
- Folding Architecture [9th print Paperback] by Sophia Vyzoviti.
- Folding Techniques for Designers: From Sheet to Form [Paperback] by Paul Jackson.

Tool
7



**Model Making
with Paper**

Participant Handout

Model Making with Paper

Like model making with blocks, using paper provides a hands-on way for participants to express thoughts about space and provide creative and emotional input. This time, however, participants use material techniques, rather than pre-made objects. As a result, these basic paper model making materials provide more of a blank canvas upon which participants can imprint their unique view of the world. For example, ripping, doing rubbings, and folding and scrunching paper, chip board, acetate, or vellum can provide participants with greater flexibility in creating ideas about how space can be designed for refuge, privacy, or security. You can also draw or add images from magazines to create a richer vision for your space.

Model Making with Paper exercise

This sample exercise introduces you to the basics of model making, skills that you can then apply to the creation of models of other spaces.

You will receive a two-dimensional paper copy of a house. If not done already, cut or tear the house and the small square out of the paper. Once you have the basic flat form of the house cut out, loosely fold it along the solid lines. Glue the provided chipboard base into the center of the house, so it forms the floor. Glue the paper floor of the house onto the base. You can now attach the walls together to form the house. To do this, fold down and overlap the tabs on the adjacent walls and attach them to each other using double-sided tape or glue. You are now ready to finish the house by folding down the roof and taping it to the side wall. You now have created a model house with paper.

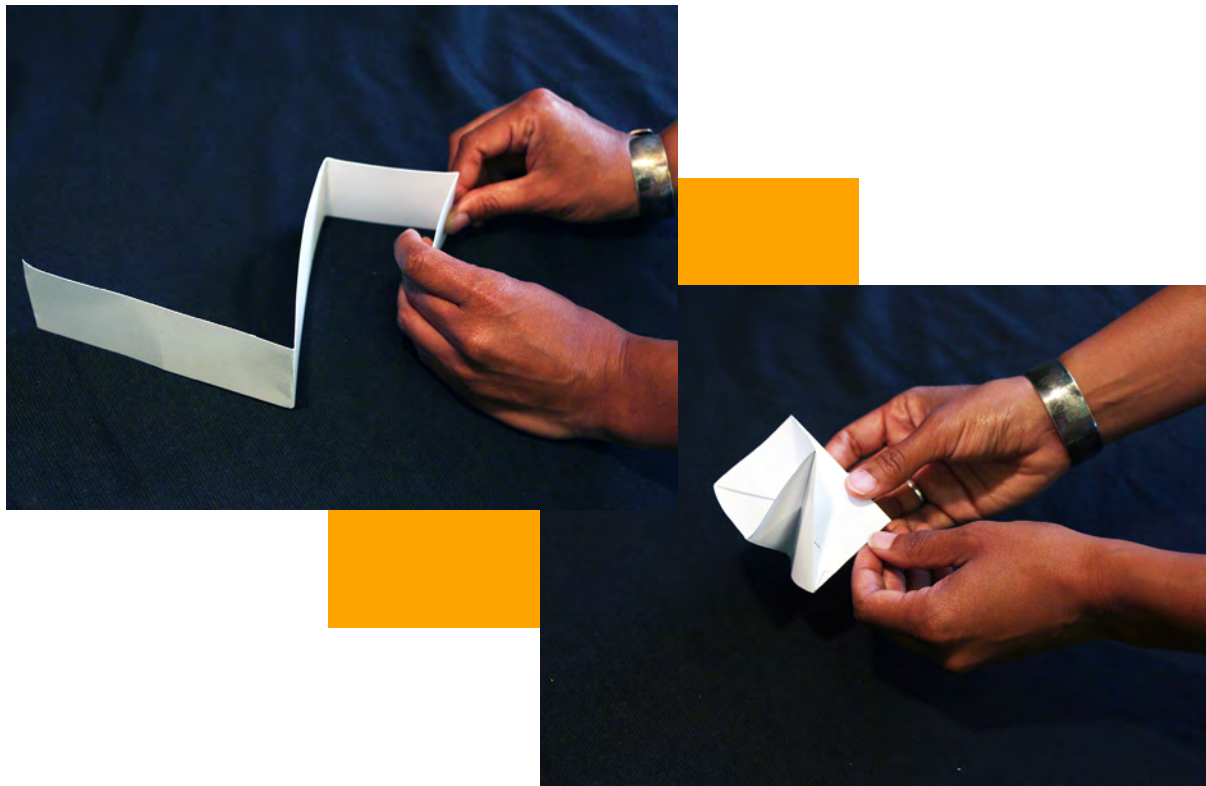

Tool
7



**Model Making
with Paper**

Templates

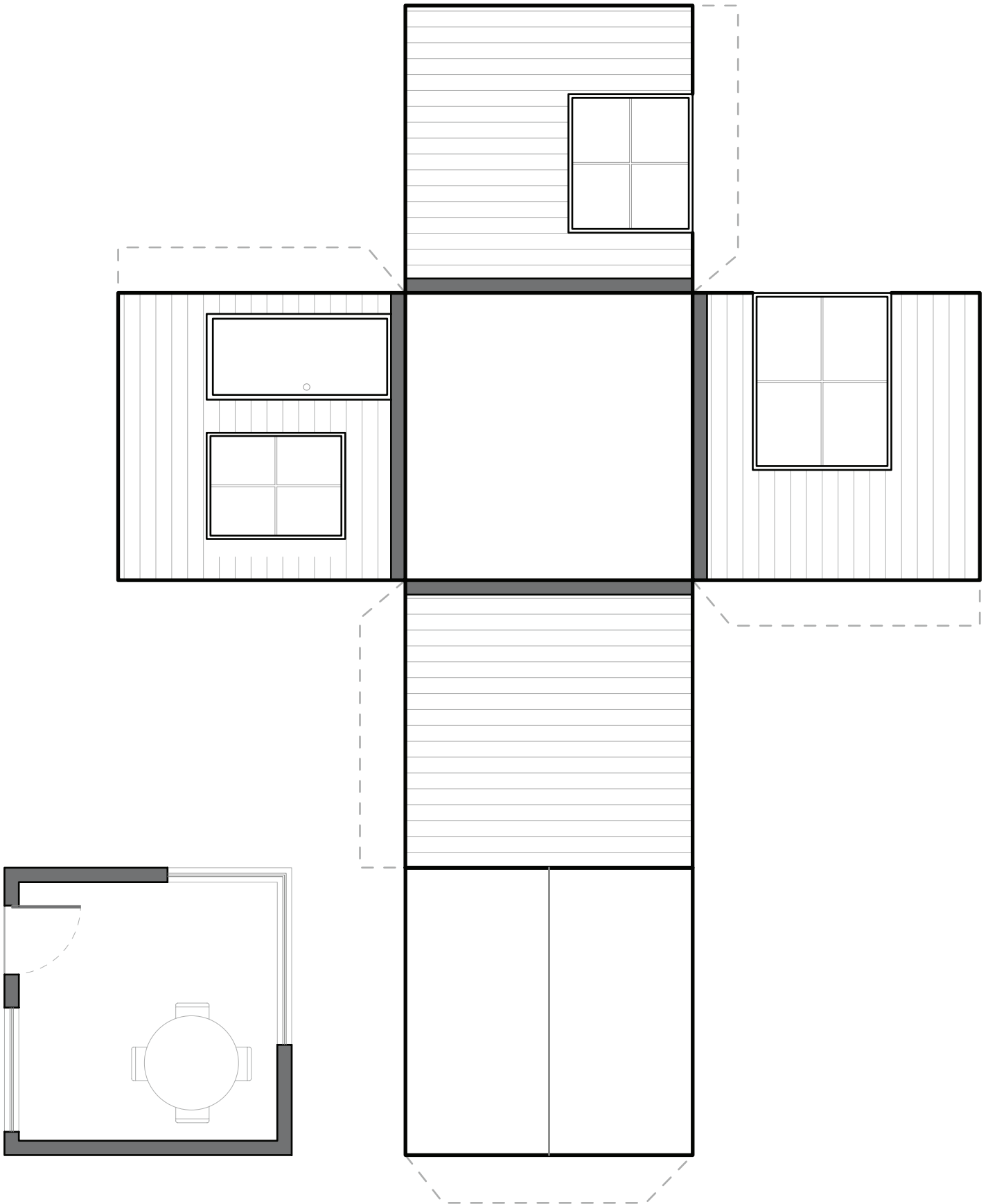



Tool 8



Checklists & Assessments

Item	Current Conditions	Needs	Staff or Facilities
Chairs/Seating	What seating is currently in the space? Is it in good condition and support your needs? Do you need more or different seating? Are chairs for circles of Equal height? Is there a place to store them?	List the furniture you need. Sketch furniture layout.	staff or facilities needed to get the furniture required for the workshop, class or circle
Tables	What activities in the space require a desks or tables? Is it the right shape and size for this use? Can it be folded and stored and easily moved?	List the furniture you will need. Sketch out where it might go in the space.	Where can I get the furniture I need? Can staff or facilities help get the furniture required for the workshop, class or circle
Other Furniture	What other furniture is currently in the space? Is it in good condition and support your needs? Do you need more or different types of furniture?	List the furniture you will need. Sketch out where it might go in the space.	Where can I get the furniture I need? Can staff or facilities help get the furniture required for the workshop, class or circle
Furnishings	What furnishings are currently in the space? Pillows for sitting on the ground? Blankets? Fabrics?	List the furnishings you need. What furnishings can be created to enhance the space?	Who can help? Where can I get buy or get these made?
Color & Art	Is there color in the space? Is the color employed going to stimulate the reaction you are seeking? Is there artwork on the walls? What does it depict?	What color or art can you use to create restorative and nourishing environment? Where would it be located in the space? How do you create it?	Are there artists or designers in your community who could work with you to create these elements?
Nature	Is there nature or natural element in the space? Are there moving water or plants?	How can you increase the natural elements in the space? Is there enough light to grow plants? Can animals be brought in?	If you can bring in nature, animals or water who will take care of this? Can it be easily maintained?
Facilities			Facilities staff



Description

Checklists and Assessments

Checklists and assessment tools provide a clear and helpful way to analyze existing spaces and create new spaces informed by restorative justice. These tools guide users in what to notice in their environments and a process for analyzing design elements in their spaces. They are also helpful in quantifying and organizing a process toward the creation of these spaces. In this tool, there are several checklists and assessment tools that you can use to help understand and evaluate your spaces at any stage of the design process. The checklist and assessment tools provided here can serve as activity sheets for workshop assignments or be distributed among stakeholders in real-world design projects, as a way of help them analyze their own spaces and share learnings with colleagues and users. You can also invite stakeholders to create their own assessment tools, based on their design goals.



**SAMPLE EXERCISE*****Making space for restorative justice and peacebuilding***

Give each participant a copy of the Making Space of Restorative Justice and Peacebuilding checklist and assign them, individually or in small groups, a space to evaluate using the checklist. After they have completed their assessment, they report back to the group about their findings. Facilitate a large group discussion about their findings. For instance:

- What is the most interesting or important finding?
- How are the findings similar and different across assessments?
- What do their assessments suggest about the strengths of the existing design?
- What do their assessments suggest about areas for improvement of the existing design?
- If they were going to start making improvements, what improvements would they make first and why?



Plan and Process

Use this tool to:

- Invite participants to explore the design and their experiences in spaces in their own lives.
- Solicit participants' inner wisdom about the impact of design on the human experience.
- Encourage reflection on ways to change one's personal or professional spaces.
- Explore spaces at various levels (e.g., room, building, neighborhood, city).

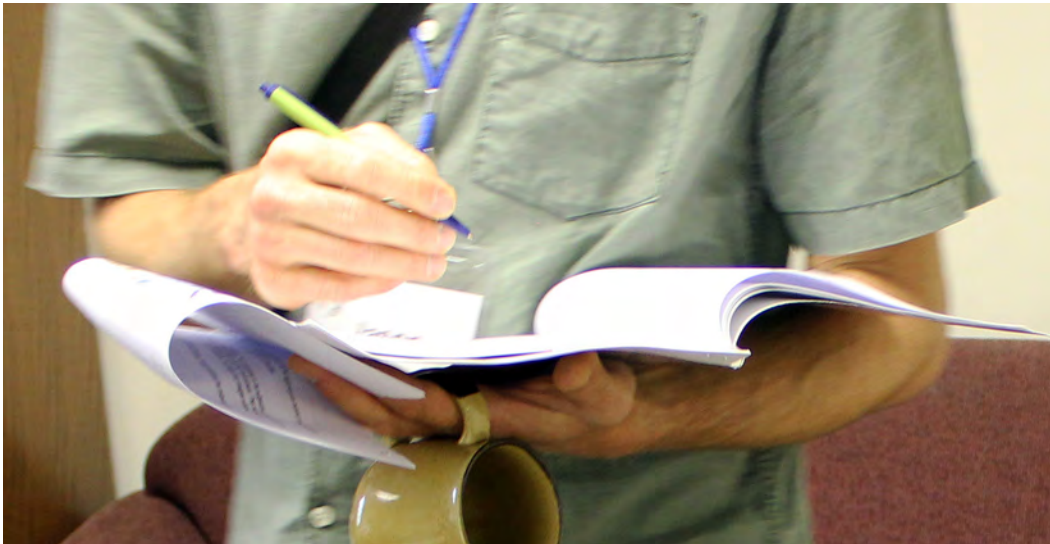



Modify the sample exercise

Participants can use existing checklists/assessment tools or create their tools as a class project.

Exercise 1: Use an existing tool

Several sample restorative justice-related assessment tools are provided in this toolkit:

- Making Space for Justice and Peacebuilding.
- Environmental Reflection.
- Trauma-Informed Design Considerations.
- Making Space for Justice and Peacebuilding in School.

Exercise 2: Participants create their own tool

Participants can also be given the assignment to create their own checklist/assessment tool, as a way to apply learnings about restorative justice. A sample prompt is as follows:

Imagine that a correctional administrator wants to assess his/her correctional institution for the way it is consistent with restorative justice and she/he has asked for a tool—for example, a list of questions or rating scales—that staff and incarcerated individuals can use to analyze that particular institution. Based on your experiences in the class and with this project, create an assessment/evaluation tool.

Participants may look at existing tools to get an idea of what they might want to include or how to format their tool.

Present and debrief the design tool

Students present their assessment findings (and assessment tool, if created from scratch). Sample debriefing and discussion questions include:

1. What design elements are consistent with restorative justice?
2. To what degree is the space being assessed restorative?
3. What changes could be made to make it more restorative?
4. What is their most interesting or important finding?
5. How are the findings similar and different across assessments?
6. What do their assessments suggest about the strengths of the existing design?
7. What do their assessments suggest about areas for improvement of the existing design?
8. If they were going to start making improvements, what improvements would they make first and why?



Make and Build

In this section, you will find sample checklists and assessments tools for your use. Other than copies of the assessment tool you want participants to use, the supplies are minimal:

- Pen or pencil
- Copies of existing checklists/assessment tools.
- Paper on which participants can create their own checklists/assessment tools.
- Instructions for how to guide students in creating checklists/assessment tools.



Tool
8



**Checklists &
Assessments**

Assessments Handout



Checklists and Assessments

Checklists and assessment tools provide a clear and helpful way to analyze existing spaces and create new spaces informed by restorative justice. These tools guide users in what to notice in their environments and a process for analyzing design elements in their spaces. They are also helpful in quantifying and organizing a process toward the creation of these spaces. In this tool, there are several checklists and assessment tools that you can use to help with understanding and evaluating your spaces at any stage of the design process. You can also invite stakeholders to create their own assessment tools, based on their design goals.

Checklists and Assessments exercise

Using the Making Space of Restorative Justice and Peacebuilding checklist, evaluate the assigned space. You may do this individually or in a group. After you have completed the assessment, you will report back to the group about your findings and participate in a large group discussion around the following questions:

- What are the most interesting or important findings?
- How are the findings similar and different across assessments?
- What do your assessments suggest about the strengths of the existing design?
- What do your assessments suggest about areas for improvement of the existing design?
- If you were going to start making improvements, what improvements would you make first and why?

Sample Assessment 1

Things to consider: A checklist for creating restorative spaces

Often when we look at our current spaces for justice including prisons/jails, classrooms, offices, or courthouses, they do not embody the values we would like to see represented and are sometimes designed or furnished for uses other than those intended to use them. This checklist provides a guide to help you analyze your current spaces in order to enhance or transform them for restorative justice and peace building in your context. Not all of these elements may apply, and you may not be able to make significant change to your environment. There may even be some items not listed here that fit your context so feel free to add what you are missing. The intent is to use this to get you started and to explore even the smallest change that you might be able to make to create a space that embodies the values of restorative space.



Space Analysis					
Item	Current Conditions	Design Strategies	Resources/Knowledge	Notes	Budget
Space Analysis	Does the space feel cramped or too spacious? Is there ample room to move outside of the circle? Is there enough space for the number of people participating in the peacemaking process and design labs or art work? Can everyone see each other?	How can I reorganize the space differently? What needs to be removed?			
Windows and Views	How do people enter the room? What is the first thing they see? Is there a view to nature through windows? If not what do you see?	How can I reorganize the space differently to create a positive entry experience?			
Sound/ Acoustics	Is the room sound proof? Are there distracting sounds from outside? Can everyone be heard easily within the space?	Can I add soft furniture or furnishings to reduce noise attenuation? Do I need to remove items to create a louder or quieter room.			
Temperature	Is the space too cool or warm? How is temperature controlled in the room? Fans? Central Air? Can you open the windows? Are there cooler/hotter spaces in the room?	Can furniture be placed in a part of the room with the best temperature control? Do we need to have blankets on hand? Can we add fans for cooling? Open windows?			
Support Spaces	Is there space for storage? What do you need to store? Extra Chairs? Process supplies? Are there convenient and clean bathrooms nearby?	Do you need to purchase storage furniture?			
Privacy	Can people be seen or heard while in the peacemaking circle? Sleeping? Taking care of physical needs? Are there places for reflection and quiet time?	How can you create spaces for privacy that still feel safe for all?			

Lighting					
Item	Current Conditions	Design Strategies	Resources/Knowledge	Notes	Budget
Artificial Lighting	<p>What mood does the lighting produce?</p> <p>Are you relying on overhead florescent lighting?</p> <p>Can you control it with dimmers?</p> <p>Is it too dark? Too much light?</p>	<p>What mood would you like to create? Can current conditions be modified? Do you need to add lighting?</p>	<p>Who can help? Where can I get materials?</p>		
Natural lighting	<p>Does the room have natural lighting?</p> <p>Which direction are you facing? North? South?</p> <p>Where is the light fall in the room throughout the day? The year?</p> <p>What time of day is your circle process?</p>	<p>How can we bring more natural light into the space if necessary?</p>	<p>Who can help?</p>		
Blinds, Window Coverings	<p>Do window coverings provide sufficient privacy and reduction for glare?</p> <p>What condition are they in?</p>	<p>How can window coverings contribute to the overall look and feel of the space and control glare?</p>	<p>Who can help? Where can I get materials? Volunteers?</p>		

Furnishings					
Item	Current Conditions	Design Strategies	Resources/Knowledge	Notes	Budget
Chairs/Seating	What seating is currently in the space? Is it in good condition and support your needs? Do you need more or different seating? Are chairs for circles of Equal height? Is there a place to store them?	List the furniture you will need. Sketch furniture layout.	Where can I get the furniture I need? Can staff or facilities help get the furniture required for the workshop, class or circle		
Tables	What activities in the space require a desks or tables? Is it the right shape and size for this use? Can it be folded and stored and easily moved?	List the furniture you will need. Sketch out where it might go in the space.	Where can I get the furniture I need? Can staff or facilities help get the furniture required for the workshop, class or circle		
Other Furniture	What other furniture is currently in the space? Is it in good condition and support your needs? Do you need more or different types of furniture?	List the furniture you will need. Sketch out where it might go in the space.	Where can I get the furniture I need? Can staff or facilities help get the furniture required for the workshop, class or circle		
Furnishings	What furnishings are currently in the space? Pillows for sitting on the ground? Blankets? Fabrics?	List the furnishings you need. What furnishings can be created to enhance the space?	Who can help? Where can I get buy or get these made?		
Color & Art	Is there color in the space? Is the color employed going to stimulate the reaction you are seeking? Is there artwork on the walls? What does it depict?	What color or art can you use to create restorative and nourishing environment? Where would it be located in the space? How do you create it?	Are there artists or designers in you community who could work with you to create these elements?		
Nature	Is there nature or natural element in the space? Are there moving elements in the space like a mobile? Are there representations of nature in the space?	How can you increase the natural elements in the space? Is there enough light to grow plants? Can you bring animals into the space? Can you bring water elements into the space?	If you can bring in nature, animals or water who will take care of this? Can it be easily maintained?		
Equipment	What sound & audio equipment, teaching aids, messaging, fire and security system or building system equipment is in the space.	Do these clutter the space? Are they still necessary for your use? Is there equipment you are missing that is required for the space?	Are there facilities staff who can help you with this?		

Building					
Item	Current Conditions	Design Strategies	Resources/Knowledge	Notes	Budget
Entrance	How do the parties enter the building? Is there a transition from public to private? Are there plantings, art or water features? Is there an elevation change(stairs).	How can you enhance the entry experience into the building? Can you create an intermediate space or lobby waiting area that feels inviting safe and nourishing?			
Security	How is security maintained? Does the security method also intimidate the parties?	What methods can you explore to keep people safe and not violated or intimidated? Are two separate entrances necessary?			
Location	Is the location convenient to both? Does it seem to favor one or the other? Are you located near or within your community? Do you feel safe here?				

Sample Assessment 2

Making space for peace: A checklist for creating restorative spaces in schools

Often when we look at our current educational spaces they do not embody the values we would like to see represented and are sometimes designed or furnished for uses other than restorative justice. This checklist provides a guide to help you analyze your current spaces in order to enhance or transform them for restorative justice and peace building within a school setting. Not all of these elements may apply and you may not be able to make significant change to your environment. There may even be some items not listed here that fit your context so feel free to add what you are missing. The intent is to use this to get you started and to explore even the smallest change that you might be able to make to create a space that embodies the values of restorative space.



The Building: Locating Your Space

Map Your School

Place a basic map of your school here and Use this sheet with your staff or with students to map the school. With colored pencils or markers Identify territories and hangout spots for different groups. What are the most traveled routes? Where do students and teachers feel most comfortable? Where do they feel uncomfortable?

	Observations	Ideas/ Solutions	Action Plan
Day Lighting	Does the room have natural lighting? What direction do the windows face (North South East West)? Where and when is light entering the space? Do window coverings provide sufficient privacy and protection from glare?	Ex. Buy or Make Curtains	Ex. Reach out to school faculty and see who can sew.
Windows & Views	Do you have windows? Is the window to wall ratio close to 25%? What do you see from your space? Are there elements that can be added to or removed to improve the views? Are their interior blocks to your view i.e. bars, furniture etc?		
Access to Nature	Do you have easy access to an outdoor space for circles? Direct or indirect? Is it shaded and comfortable? Is there adequate privacy?		
Privacy Neutrality	Are you located in a place where you can have privacy? Is you space located where everyone feels comfortable going? What did you learn from your mapping and observation activity in the school? Is there a vestibule or transition from public to private like a hallway or lobby?		

Making Restorative Environments

Use these criteria to create a safe space for peacemaking space in your school.

Draw Your Space

Draw a sketch of how you would like to layout your space. What activities will occur in the space? Is there enough room for everything you want to do? Where do circles happen? Where does the program coordinator sit?

Making Restorative Environments

	Observations	Ideas/ Solutions	Action Plan
Entry	How do people enter the room? What is the first thing they see? Is there an opportunity for a vestibule to create a transition zone?		
Proximity	Is there ample room to move outside of the circle? Is there enough space for the number of people participating in the peacemaking process? Can everyone see each other? Does the space feel cramped or too spacious?		
Activating Walls	Are walls free of unnecessary items/clutter?		
Furniture	What furniture do I need?		
Furnishings	Do windows need curtain blinds? Are there opportunities for soft furnishings?		
Lighting	What mood does the lighting produce? What kind of lighting do I have (halogen, fluorescent, incandescent?) How is it controlled? Who maintains it?		Quantities, Specifications: How many lights do I need? What kind?
Sound/ Acoustics	Is the room sound proof? Are there distracting sounds from outside? Can everyone be heard easily within the space?		
Temperature	How is the space heated and cooled? Who controls this? Is the space too cool or warm? Where is your thermostat? What time of day is your circle process? Where is the sun coming in?		
Support Spaces	Is there space for storage? What do you need to store? Extra Chairs? Process supplies? Are there convenient and clean bathrooms?		

Sample Assessment 3

Trauma-informed Environmental Design Considerations

1. For whom is the environment designed and who will be using it?
(Individuals, groups, support people, informal care providers, families, professional staff, etc.)
2. What is the trauma experience of those within the environment?
(Primary/vicarious, child abuse, natural disaster, combat, incarceration, homicide, etc.)
3. What does the trauma experience suggest about the trauma healing needs of those within the environment?
4. What are the goals and mission/vision of the facility and in what ways are they trauma-informed?
5. What activities/services are provided within the facility and in what ways are they trauma-informed?
(Individual or group programs, housing, relief services, counseling, leisure activities, etc.)
6. In what ways does the space achieve the following and through what architectural and design features (including location):
 - Communicate healing messages to those who use it.
 - Provide for safety (physical, psychological, emotional).
 - Allow users to control and adapt the space to suit their needs and activities.
 - Promote positive social interaction and support between clients and with other people outside the facility, including their communities of care.
 - Facilitate positive interactions between staff, clients, and communities of care.
 - Minimize feelings of stress.
 - Provide areas for temporary escape, rest, and privacy.
 - Offer access to nature or natural views.
 - Offer access to diversions and entertainment.
 - Create opportunities for happiness, optimism, and hope.
 - Allow people to create or maintain routines.
 - Promote strengths and resiliencies.
 - Attend to spiritual needs.
 - Provide learning opportunities for clients and communities of care;
 - Promote the use of a variety of healing practices.
 - Use general design features known to improve health (light, color, music, air, etc.).

7. In what ways does the ethos/milieu of the space promote the following for and among clients and staff:

- Control, self-efficacy and self-determination.
- Belonging.
- Validation of experiences.
- Participation of all, staff and clients.
- Interrelatedness and mutual responsibility.
- Appropriate emotional management.
- Respect.
- Predictability.
- Safety (emotional, physical, psychological).
- Strengths and resiliencies.
- Communication.
- Organic leadership.
- Teamwork.
- Collaborative and consensus based decision-making, including staff and clients.
- Nonviolence.
- Mutual responsibility.
- Optimism and hope.
- Common language of trauma to frame mission, work and interactions.



Sample Assessment 4

Spaces Where I Work and Live

As you prepare for the workshop, take some time to pay attention to and observe the settings and spaces in which you work and live. Consider two types of spaces:

1. Those that represent or contribute to feelings of peacefulness, justice, and healing.
2. Those that represent or contribute to feelings of conflict, injustice, and harm.

Select one setting/space from each of the two categories to reflect on more deeply and about which to record impressions. Below are some questions to guide your reflection. While the questions are framed around your experiences, also consider how others may experience the setting (e.g., those engaged in conflict or those who have experienced trauma). We will actively draw on your insight and experiences in class.

You are encouraged to take photos of spaces, if possible, and record reflections and sketch in a visual diary, all of which can be brought to the first session.

Guiding questions

Consider the following questions for each of the settings you chose to focus on:

1. What does the setting look, feel, sound, and smell like?
2. What of the setting elicits the following responses, if any, from you? What other responses does it elicit?

Belonging	Humiliation	Dignity	Validation
Safety	Chaos	Hope	Exclusion
Stress	Restoration	Isolation	Calm
Violence	Support	Vulnerability	Hopelessness

3. What is the role and presence of nature in your setting? For instance:
 - What forms of nature are present?
 - What forms of nature do you wish were present?
 - How do you and others interact with the natural elements in the space?
 - How does your interaction with nature, or lack thereof, impact you? Others?
4. What behaviors occur in this space? For instance:
 - How do you and others use the space?
 - How do you and others act and behave in this space?
 - How do you and others organize or position themselves in this space?
 - Where do people congregate (e.g., sit, stand, visit, meet) in the space?
 - What is the nature of relationships that take place within this space?

5. In what ways does the design of the setting/space serve to:
 - Marginalize or exclude certain individuals or groups.
 - Build community.
 - Respect diversity, especially religious and cultural diversity.
 - Disempower certain individuals or groups and empower others.
 - Offer opportunity for privacy, when needed.
6. How would you describe the culture or “personality” of the setting, and how does the physical space contribute to that culture?
7. What values are communicated through the design of the setting? To what degree are these values consistent with peacebuilding, justice, trauma healing, restorative justice, and other forms of conflict transformation?
8. If you could change any part of your setting so that it is experienced as more peaceful, just, and nourishing, what change would you make?
9. How do the work-based settings that you reflected on compare and contrast to the settings and spaces in which you live and play?



Tool
9



Photo Analysis

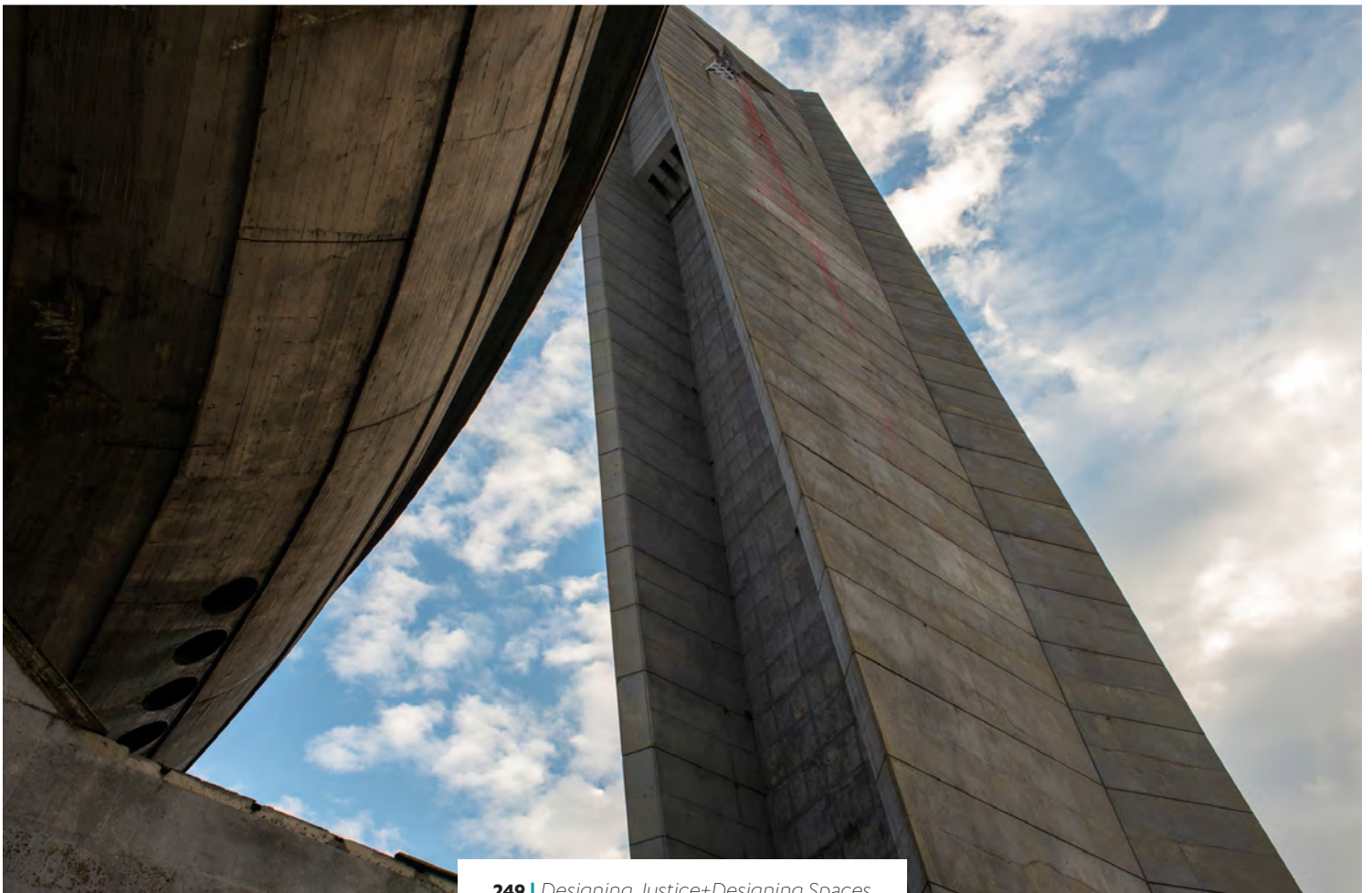



Description

Photo Analysis

We are surrounded by visual stimuli and images every day and, even if we do not pay attention, the visual world impacts how we feel, act, and relate. Photo analysis invites us to pay close attention to what we see and explore the meaning, characteristics, and impact of the images of our world. By analyzing an image's content, we can learn about the design of spaces we enjoy and those that we avoid. Because each viewer sees the world differently, each person analyzing an image will offer important and unique insight about the image.

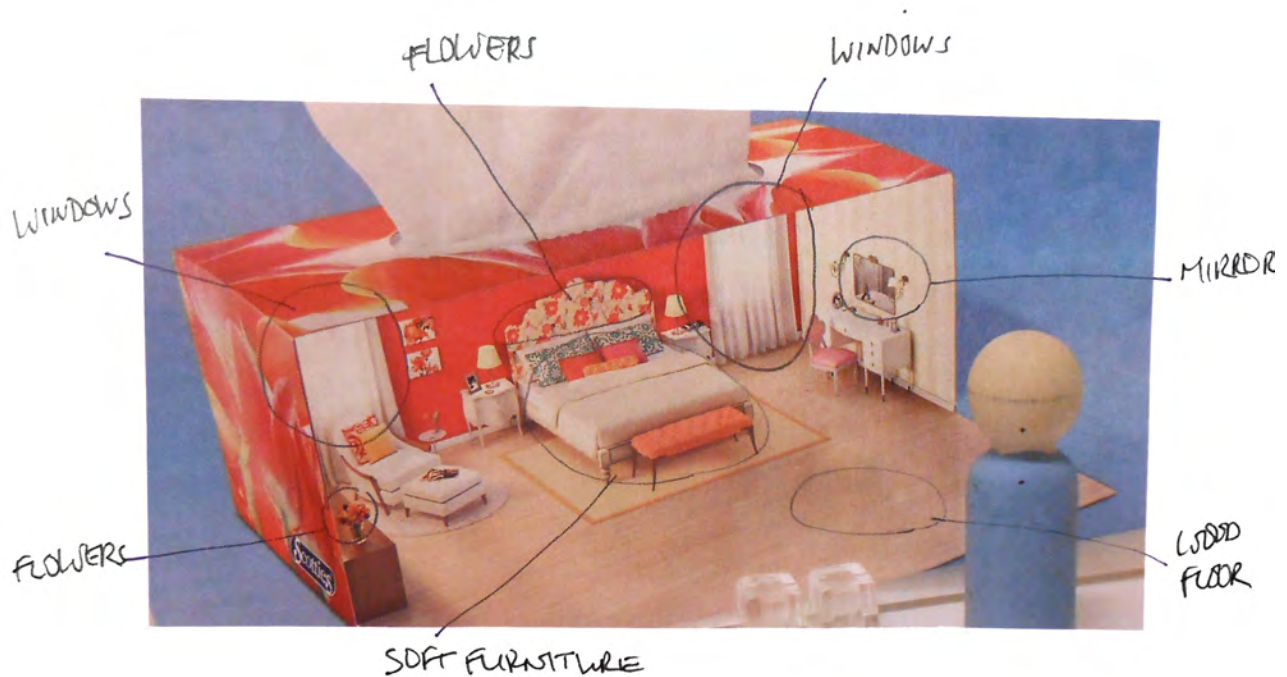



Plan and Process

Use this tool to:

- Facilitate reflection and design during sessions.
- Plan for individual and group design projects.
- Explore different viewpoints on polarizing topics.
- Encourage participation from those who may be less confident in their verbal communication skills.
- Engage students who may not feel confident in their writing skills.
- Facilitate learning on topics other than restorative justice.

Modify the sample exercise

Exercise 1: Analyze an image of your choice

Invite participants to select their own image for analysis by making available a wide selection of images to pick from in response to a prompt. For example, you could offer one of the following prompts:

- Select an image that represents a space, or characteristic of a space, in which you could face the worst thing you have ever done.
- Select an image that represents a space, or characteristic of a space, in which you could work through an experience with victimization.
- Select an image that represents a space, or characteristic of a space, that represents restoration (or love, accountability, etc.)

Exercise 2: Analyze an image selected by another participant

As in Exercise 1 above, participants select their own images in response to a prompt. Rather than analyze the image they selected, however, they analyze that of a fellow participant.

Present and debrief the design tool

Invite students to share their analysis with the class, using discussion questions such as:

1. What are recurring themes that surface in the analysis?
2. What new insight did you gain about an image because of the analysis?
3. In what ways do analyses of the same image differ from each other?



Make and Build

Image analysis requires few supplies, simply images, and instructions.

Images

Images may come from a variety of sources—magazines, facilitator’s photographs, or ones participants bring with them.

Instructions

The handout, adapted from a worksheet created by the National Archives (Washington, D.C.), offers instructions, categories, and reflection questions for analysis.



Tool
9



Photo Analysis

Participant Handout

Photo Analysis

We are surrounded by visual stimuli and images every day and, even if we do not pay attention, the visual world impacts how we feel, act, and relate. Photo analysis invites us to pay close attention to what we see and explore the meaning, characteristics, and impact of the images of our world. By analyzing an image's content, we can learn about the design of spaces we enjoy and those that we avoid. Because each viewer sees the world differently, each person analyzing an image will offer important and unique insight about the image.



Photo Analysis exercise

Use the worksheet and instructions on the back of this page, analyze the assigned photo. You may choose to mark up the photo itself or write notes on the handout or a separate sheet of paper to complete this exercise. After you have finished your analysis, respond to the questions at the bottom of the page.

After everyone has completed their individual analysis, you will participate in a large group discussion.

Architecture/ Interior Design	
Culture/Religion	
People/ Relationships	
Activities	
Objects	
Atmosphere	

1. If you gave this image a title, what would it be?
2. What characteristics are most prominent or recurring in this image?
3. What emotions does the image elicit in you?
4. How would you use the space in this image?
5. What metaphors come to mind when you consider the meaning of this image? For instance, images in which one feels held and comforted may bring the notion of being “nested.”

Tool
10



Interviews





Description

Interviews

A successful design project requires the input from individuals who have a vested interest in the project. This includes those who will actively use the space as well as those who will oversee and interact with the site and its purposes in other ways. In the criminal justice context, these stakeholders include those who have committed offenses as well as those who have been victimized and their families/friends, community members, justice professionals (e.g., victim service providers, judges, attorneys, correctional administrators, security officers), social service providers, and civic representatives (e.g., law enforcement officers, government officials). These interviews give life to restorative justice in the design process for the way they actively engage those most impacted by the project.



Interviews with these individuals or groups of individuals serve to solicit their ideas and perspectives for the design project and its elements, which are then considered and incorporated into the final concept. As such, interviews are not meant to merely seek stakeholder support for the ideas and intentions of the project leaders or design team. Ideally, interviews take place from the start of the project through to the end. Stakeholder input can be sought on all areas of the project. For instance:

- Location of the project.
- Goals of the site.
- Values that will shape the creation of the site and its use.
- Programs and services to be offered at the site.
- Architectural and design features of the site.
- Evaluation of the completed project.

With helpful questions in hand, participants can generate many new and important ideas to incorporate into their designs. While listening to interviewees share their perspectives, the interviewer will listen for what they say, or imply, about values that are important, metaphors, relationships to be facilitated, and design themes.

The Make and Build section includes a sample interview guide. Two participant handouts introduce interviews and the creation of an interview guide as well as how to develop and ask helpful questions.



SAMPLE EXERCISE

Interviewing justice stakeholders

Give participants an introduction to the importance of interviewing, drawing on the description above and explain that they will be conducting interviews to solicit input for their design concepts.

As a large group, generate a list of all the people who have a vested interest in the project for which they will be creating design concepts. Discuss, as a group, who on this list they will have access to over the next day or two so they can conduct several interviews.

Transition the conversation to talk about the types of questions to ask during these interviews. Again, invite the group to brainstorm characteristics of helpful and unhelpful questions, giving examples as you go. Be sure to enforce that there are no such things as bad or stupid questions; rather, questions can be worded in a way that moves the conversation forward or slows it down. The Asking Helpful Questions handout provides several questions that are poorly worded, which students can practice rewording so they are more helpful.

After the participants have generated the list of stakeholders and practiced writing design questions, invite them to work in dyads or triads to generate a list of specific design questions they can use in their interviews. They can write their questions on the Interview handout. After they have had time to create a few questions, invite each group to read a few of their questions to the rest of the group. Offer suggestions on how to improve how questions are framed. You may also invite participants to practice interviewing each other.

Offer final instructions to the participants about their interview assignment and provide time for them to ask questions. At the next session, invite participants to share who they interviewed, what they learned, and ideas the interviews generated for the design concept. Sample questions include:

1. What new insight did you gain about your design?
2. How does the insight vary across the different stakeholders?
3. What are most important or interesting insights gained?
4. How will you change or enhance your design based on what you learned?
5. What did you learn about design in the process of interviewing?
6. What was most challenging about doing the interviews?
7. What was most rewarding about doing the interviews?



Plan and Process

Use this tool to:

- Solicit input for design concepts.
- Provide opportunities for participants to discuss their learnings.
- Explore multiple perspectives on a single project.
- Practice listening skills.

Modify the sample exercise

The interviewees and interview questions are unique to each project and the central goal of the sample exercise is the creation of an interviewee list and the interview questions.

Exercise 1: Design team preparation

Participants brainstorm stakeholders and interview questions in the design teams that have been formed to create design concepts as the final project. When completed, they present their list of stakeholders and questions to the large group. Discuss using the questions in the sample exercise.

Exercise 2: Design team practice interviews

After having developed interview questions, members from one design team interview the members of another design team as a way to feel comfortable interviewing and to practice asking their questions.



Make and Build

Other than copies of the Interview handout and Asking Good Questions handout, the interview supplies are minimal.

- Pen or pencil
- Visual diary (in which to take interview notes)



Sample interview guide

Below is a sample interview guide, created to solicit input for a re-entry campus that would also serve as a community gathering place.

1	Give some background to the project to ensure that interviewees know what you are talking about prior to starting.
2	Opening question – What are your thoughts about creating a place for re-entry that you and others in the community could share?
3	Follow-up questions – a. If you were coming to this place to work, play, get assistance, or just hang out, what kind of spaces would you want? b. What values do you want to see represented in the spaces? c. What is your favorite place in your community and daily life? Why? d. Tell us about a typical day. e. What are your dreams or vision for this place? f. Imagine you and your family are visiting the site. Tell me a story about what you did there that day. g. What would you need to feel comfortable coming here for the first time? h. How do you feel when you drive by the corner of Mission Blvd and Hampton Rd, the proposed site of the campus? i. How do you want feel when you drive or walk by this site?
4	Closing question - Is there anything I did not ask you?

While interviewing, listen for the following:

- Values that are important.
- Metaphors that interviewees use to describe their experiences or perspectives.
- Emotions or nonverbal signs when they are talking.
- Relationships that may develop or be nurtured in the space.
- Design themes: nature, sound, textures, color, furniture, objects etc.

Tool
10



Interviews

Participant Handout



Interviews

A successful design project requires the input from individuals who have a vested interest in the project. This includes those who will actively use the space as well as those who will oversee and interact with the site and its purposes in other ways. In the criminal justice context, these stakeholders include those who have committed offenses as well as those who have been victimized and their families/friends, community members, justice professionals (e.g., victim service providers, judges, attorneys, correctional administrators, security officers), social service providers and civic representatives (e.g., law enforcement officers, government officials). These interviews give life to restorative justice in the design process, for the way they actively engage those most impacted by the project.

Interviews with these individuals or groups of individuals serve to solicit their ideas and perspectives about the design project and its elements, which are then considered and incorporated into the final concept. As such, interviews are not meant to merely seek stakeholder support for the ideas and intentions of the project leaders or design team. Ideally, interviews take place from the start of the project through to the end. Stakeholder input can be sought on all areas of the project. For instance:

- Location of the project.
- Goals of the site.
- Values that will shape the creation of the site and its use.
- Programs and services to be offered in the site.
- Architectural and design features of the site.
- Evaluation of the completed project.

With helpful questions in hand, participants can generate many new and important ideas to incorporate into their designs. While listening to interviewees share their perspectives, the interviewer will listen for what they say, or imply, about values that are important, metaphors, relationships to be facilitated, and design themes.

Interview activity

For this activity, you will be interviewing stakeholders to gather their input for your design. The first task is to generate a list of all the people who have a vested interest in the project for which you will be creating a design concept.

The second task is to generate a list of questions that you will ask during these interviews. You will want to be sure that the questions you ask are helpful in gathering information. Individually and as a group, consider the characteristics of questions that engage people in talking to you and which ones are less helpful in engaging people. You are then ready to create specific design questions, using the worksheet on the back of this page. When completed, share and compare your questions with the rest of the group.

Select previously identified stakeholders who you will see or talk to before the next session. Interview these individuals and record interview notes in your visual diary.

Interview guide

Use this space to write down your interview questions. You are already provided with a way to start the interview, a closing question and things to listen for during the interview. You will create your opening question and other questions you will ask after you get started.

1	Give some background to the project to ensure that interviewees know what you are talking about prior to starting.
2	Opening question –
3	Follow-up questions –
4	Closing question - Is there anything I did not ask you?

While interviewing, listen for the following:

- Values that are important.
- Metaphors that interviewees use to describe their experiences or perspectives.
- Emotions or nonverbal signs when they are talking.
- Relationships that may develop or be nurtured in the space.
- Design themes: nature, sound, textures, color, furniture, objects, etc.

Asking Helpful Questions

Think back on various conversations you have had. Ever notice how some questions and statements keep the conversation going while others seems to fall flat, stopping a conversation in its tracks? Part of the reason that this occurs is because some questions are phrased in a helpful way, inviting more interaction, while other questions are less helpful, and do not have the same invitation.

Interviewing requires the use of questions, or statements, that encourage the interviewee to keep talking and tell you about their needs, desires, and ideas. Below are some ideas for how to ask questions that help keep the conversation going.

Helpful questions/statement	Unhelpful questions/statements
Open <ul style="list-style-type: none"> • Invites speaker to open up to provide more information or clarify what was said • Seeks lengthy answers • Suggests encouragement and curiosity 	Closed <ul style="list-style-type: none"> • Limits answers to “yes” or “no” or other 1-2 word answers • Suggests a lack of interest in understanding more • Does not offer encouragement
Asks “what” or “how” <ul style="list-style-type: none"> • Seeks understanding of motivation and reasoning • Suggests openness 	Asks “why” <ul style="list-style-type: none"> • Seeks understanding of motivation and reasoning • Suggests blame or judgment
Brief, few in number, and asked 1 at a time <ul style="list-style-type: none"> • Easy to understand • Know which question to answer • Keeps the focus on the interviewee 	Long, too many, and asked at same time <ul style="list-style-type: none"> • Difficult to understand • Don’t know which question to answer • Focus remains on the interviewee
Well-timed <ul style="list-style-type: none"> • Refrains from interrupting the flow of the interviewee • Moves conversation forward in a logical way 	Poorly time <ul style="list-style-type: none"> • Interrupts interviewee • Makes flow of conversation difficult to follow

No question is inherently helpful or unhelpful. With a bit of rewording, a seemingly unhelpful question can become a good question. For instance, you intend to create opportunities for physical fitness on the site that you are designing. The design team has been considering both a boxing gym and a swimming pool but you do not know what the community would like. One way to ask the question is as follows:

We hope this site will promote physical fitness. Which would you like more – a boxing gym or a swimming pool?

There are a few things unhelpful with this question. It is closed—the interviewee may only answer with “boxing gym” or “swimming pool.” It also does not solicit their ideas about what fitness means to them or what they would like to see in terms of fitness opportunities. For this person, they may not be interested in either of these options. The question only solicits which of the design team ideas they like more, not actually solicits their ideas.

Another way to word the question is as follows:

We hope this site will promote physical fitness. What is your favorite way to stay fit?

This question opens the door for all the ideas that the interviewee has about physical fitness. With strategic prompts to draw out more information about the who, what, where, and when of their favorite fitness activities, the interview would offer a wealth of new information about how to design for physical fitness, much of which is likely to go well beyond boxing and swimming.

Practice

Below are questions/statements that are worded poorly. Reword them to get at the same content but in a way that will keep the interviewee actively engaged.

1. Can you explain to me why you don't want this re-entry facility next to your neighborhood?
2. Do you want trees? How about flowers? What do you think of water features?
3. Do you think that you would use a meditation garden?
4. Some of us want windows all around the dialogue room so every participant has a view outside. Others just want windows in the door so there is privacy. What do you think?
5. You said earlier that walking into the old building was usually negative. Why did you feel that way?

Sample answers

There are many ways to reword the above questions. Below are just some ideas.

1. Tell me more about your concerns about the location of the re-entry facility.
2. What role does nature play in your life?
3. Tell me about spaces that you find contemplative or meditative.
4. Imagine you were creating a room where two people in conflict with each other could talk. How would you design that room?
5. You said earlier that walking into the old building was usually negative. What was it that caused you to feel that way?

Appendices



Resource List

In addition to resources provided with specific tools, we have found the following resources particularly helpful in building our own knowledge about restorative justice, architecture and design, and participatory processes.

Restorative justice

The Little Book of Restorative Justice for People in Prison by Barb Toews

The Little Book of Restorative Justice by Howard Zehr

The Little Book of Circle Processes by Kay Pranis

The Little Book of Victim Offender Conferencing by Lorraine Stutzman Amstutz

Changing Lenses by Howard Zehr

Beyond Conviction [DVD] by Rachel Libert and Tied to the Tracks Films

Peacemaking Circles: From Crime to Community by Kay Pranis, Mark Wedge, and Barry Stuart.

Architecture and design

Archidoodle: The Architect's Activity Book by Steve Bowkett

101 Things I Learned in Architecture School by Matthew Frederick

Volume #26: Architecture of Peace by Archis Journal

Volume #40: Architecture of Peace Reloaded by Archis Amsterdam

Light on a Hill Building the Constitutional Courts of South Africa edited by Bronwyn Law-Viljoen

Concrete Steel and Paint [DVD] by Cindy Burstein and Tony Heriza

Restorative Justice design: Developing New Typologies for Social Change by Deanna Van Buren

Preparing to Enter a Correctional Facility

If you have not worked inside a correctional facility as a facility employee/contractor or community-based service provider/volunteer, it is imperative that you collaborate with someone who is familiar with the particular institution in which you wish to conduct the design project. This may be correctional staff, community partners, or prison-based associations led by incarcerated men and women. There are many policies, procedures, and security concerns that influence what one is able to do within the institution and guide how one carries oneself. These considerations vary across jurisdictions so we offer the following guiding questions to prepare for a workshop:

Determining the workshop location and time

1. Does the institution have space to host a workshop? What kind of space is it?
2. How many people will the room hold, given that you hope to create work space around tables?
3. How long can you have the room at any given time, due to the institutional schedule and others who use the room? For instance, a morning slot might be from 8:30-11:00 because day programs start at 8:30 and individuals return to their cells at 11:00 for lunch and a headcount. Or, Thursday afternoons from 1:30-3:00 is the only time that a room is free.
4. How long can a workshop be, in terms of hours, given the institutional schedule, priorities, and space availability?

Recruiting participants

1. Does this restorative justice/design project align with any existing programs or staff/incarcerated interests?
2. What is the best way to recruit participants for the workshop?
3. Is it possible to post a flyer?
4. Is it possible to get a list of potential participants prior to the start of the workshop?

Supplies and equipment

1. What supplies may you bring in?
2. Is it possible to have tables in the room?
3. May you leave supplies inside the institution, if you will be there over several days?
4. Is it possible to get a copy of the “gate memo” of the approved supplies to show the security officer at the front gate?

Entering the prison

1. What clearances are needed to enter the prison, and what are the deadlines associated with that process?
2. What is the dress code?
3. Which personal effects (e.g., wallet, keys) can you bring into the institution? Which not?
4. How much before the start time of the workshop should you arrive at the facility front gate?

A word about creativity and flexibility

When working in correctional institutions, it is not a matter of if things will go awry but rather when they will go awry. Good communication and planning can minimize, but not fully eliminate, glitches. Always be flexible and creative in your response. A security officer will not let you bring in child scissors, even though they were approved? No worries, participants can use the edge of their folders as a straight edge for ripping. Lose workshop time because count went late? Just start adjusting the agenda for the day. These things are beyond your control so there is little, if anything, you can do other than respond with a smile and proceed creatively.



Design Supplies

Below you will find a sample supply list for a workshop in which most tools will be used. Due to security issues inside correctional facilities, prior administrative approval is required before bringing in any supplies. Be sure to consult with your facility liaison about the supplies you hope to use. Be creative when a supply is denied. Throughout the toolkit, we offer supply or activity modifications based on our experiences with gaining approval for supplies. We offer suggestions here as well.

“School” supplies

- Dot grid notebooks (see Visual Diary tool).
- Folders to hold handouts.
- Copies of readings.
- Class activity handouts.
- Pens and/or pencils (type of pen/pencil may be restricted).
- Facilitator materials (e.g., lesson plans, class lists, etc.).
- Flipchart.
- Flipchart markers.
- Masking tape (to post flipchart pages, if necessary).
- Nametags.

Design supplies (varies based on tools to be used)

- Paper of various weights, sizes, and colors (including poster/Bristol board, tracing paper, and plastic-y paper, like Mylar).
- Markers.
- Colored pencils.
- Erasers.
- Pencil sharpeners.
- Ruler (see the Collage tool and Template 1 for a modification).
- Adhesive (e.g., glue stick, scotch tape, double-sided tape).
- Scissors (can be child scissors; see Collage tool and Template 1 for a modification).
- Magazines and photos cut out from magazines (e.g., nature/landscapes, buildings, people, etc.).
- Wood/plastic/paper blocks of various shapes and sizes.

Notes

- Many administrators prefer that visitors use clear bags and containers when bringing in supplies.
- You may wish to request to bring a camera to photograph the participants working and their design work. If approval is denied, you may leave with the design work to photograph it outside the institution. Be sure to get approval to bring the work back into the institution. Incarcerated participants may not be able to keep their design concepts. If this is the case, a document can be created of all the work created in the workshop and handed out to participants. This document is useful, even if participants can keep their work.

Recruiting Participants

There are many ways to recruit participants for workshops and no one right way. It will depend on what works best in your particular setting, so work with your facility-based partner. This section offers some considerations.

Requirements for participation

There are no requirements, not even previous art or design experience! The beauty of design work in this context is that anyone can participate, contribute in an important way, and get something out of it. While readings are suggested, they are not required. We just suggest asking that students commit to attend the full workshop and actively participate.

Plan around the size of the room and facilitation team

The room should be big enough to allow for a seated circle of all participants and facilitators as well as work tables for individual practice and small group design work. The size of your facilitation team, including volunteers, may also influence the number of participants as it is helpful to have one facilitator/volunteer for every five students or so. This team approach not only helps in the discussion parts of the workshop but it also ensures that individual participants and small groups have access to assistance when needed.

Working through existing programs

If the institution has existing restorative justice or art programs, you can recruit students through the program staff/volunteers, whether they are incarcerated or not incarcerated. You can provide them material to distribute to potential participants and generate a preliminary list of interested individuals.

Flyers to advertise

You can create and post flyers on institutional bulletin boards (or ask staff to post them). A sample flyer follows.

Orientation session

You may find it helpful to have an orientation session prior to starting the workshop. This will ensure that everyone is clear on the goals and expectations of the workshop so they can make an informed choice about participating prior to the start. This can be a separate session held before the workshop is scheduled to begin or even the first twenty to thirty minutes of the first workshop session (after which time, those who do not want to participate can leave).

DESIGNING FROM THE INSIDE

A 10-hour workshop on restorative justice & design

INFO:

What

A 10 hour workshop on Restorative Justice and Design

When

Monday, June 16 9:00-11:30 AM & 1:30-4:00 PM

Tuesday, June 17 9:00-11:30 AM & 1:30-4:00 PM

Who

Barb Toews, RJ Practitioner & Educator

Deanna Van Buren, Design Director FOURM design+studio

Why

Can justice settings, such as courthouses and correctional facilities, be designed with restorative values and goals in mind? Can the design of spaces in which justice occurs advance the healing and transformative potential of restorative justice programs, if not provide for restoration in and of themselves? This 10-hour workshop will invite participants to explore these questions. Through readings, discussions, and the application of design techniques and processes, participants will consider the relationship between restorative justice and architecture/design.

**No previous design experience needed! You will learn design skills in a mini-design lab!
Class Limited to 12 People**

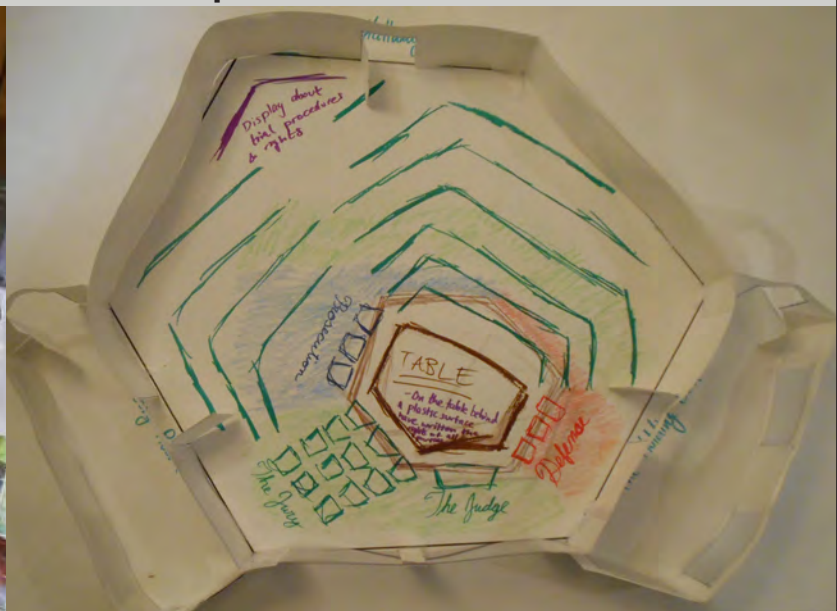

Final Design Concepts

The techniques in this toolkit can be used individually as a one-time or one-project activity. Alternately, they can be combined in such a way that participants use each of the techniques in the creation of a final design concept for a particular space, either one assigned by the facilitator or one of their choosing.

Included here are two handouts designed to assist small groups in creating comprehensive design concepts:

- **Design Team Project** – Questions for reflection and consideration as the design team starts to bring their ideas together and to co-create the concept.
- **Diagram of Team Work** – Suggestions for how to move through a creative process from the start of the concept through to the presentation of it.



Design Team Project

1: Thinking about your personal vision for the space

1. What are the restorative justice values you want the space to represent?
2. What purposes should the space serve and activities should it support?
3. What is the “feel,” smell, and look of the space?
4. What are the essential elements of the new space?
5. What from class readings and discussions do you want to be sure to include?
6. How would you organize and design the space differently to support your answers?

2: Working as a team to determine the shared vision for the space

The team will be sharing all their personal ideas and coming to an agreement about what elements will be included in the final design. Here are some guiding questions to help you determine what is most important to you and how to collaborate to ensure that everyone’s ideas are honored, even if they are not included.

1. What ideas from your personal vision for the space do you want to share with the team?
2. What ideas do you particularly like from each of your team members?
3. What are common ideas amongst the team that you can develop together?

If you are needing assistance in developing the final design concept, speak with your instructors. Design ideas are messy, generative, and creative. Most ideas will land on the cutting room floor. They are still precious so save them in your visual diary for another project in the future.

3: Working together to create the design concept

1. What skills does each team member bring to the design work?
2. Who will complete which tool?
3. How will you communicate with each other while working on your respective parts to ensure you are all working toward the same common vision?

4: Preparing the presentation

1. What are the essential elements of the design that you, as a group, want to highlight?
2. What of the design represents restorative justice and its values?
3. What parts of your design could feasibly be implemented?

1

Envisioning and telling the story of the space

As a team...

Using circles, lines, arrows, and shapes, create a **diagram** to show the activities of the space, how someone would move through the space, and how you would like them to experience the space.

Think of this as a “story” of the space. This story may be how an offender, victim or another person would use the space, why, and for what purposes.

2

Focusing the vision with 2-D detail and collage

Communicating as a team while team members begin to be responsible for a design technique...

Several team members...

- Work together to envision and draw **2-D plan(s)** of the space. If you are envisioning a building or “campus” of buildings, this plan may be for the whole collection of spaces.

- Create a **collage** to represent the ideas your team has about the space(s) - natural elements, furniture, objects, materials, art, etc.

3

Adding 3-D detail for one space

Communicating as a team while each team member is responsible for a design technique...

- Create a **3-D model** of the space or one room within the space, if overall vision includes multiple spaces.
- Create a **perspective and montage** of one part of the space.

- Continue with the drawing of the 2-D plan(s).
- Continue with the creation of a collage of the overall vision. May also create a collage for space being modeled.

4

Final design concept

Team brings together each of the design elements to form the final design concept for presentation:

- Diagram
- 2-D plan(s)
- Collage(s)
- 3-D model
- Perspective/montage

5

Presentation

Team pins up their design and briefly presents:

1. *The thinking that went into the design concept, from vision to diagram to the other elements.*
2. *The restorative justice values that the design represents.*

3. *Aspects of the design that are feasible to implement on relatively short notice and with little money.*

A panel of reviewers will provide feedback on what they see and feel in your design, ask questions, and offer suggestions.

Reviewing and Presenting Projects

One of the most critical parts of architecture pedagogy is the review/pin-up, or desk review, in which participants present their work to clients and communities or receive constructive feedback from their peers or the facilitator. This process also works well in DJ+DS workshops. These desk reviews span anywhere from 5 to 20 minutes per design concept and always includes time for the participant (or design team) to share their ideas, the reviewer to express their thoughts and for some dialogue between the two. Below are two types of review processes that you can use in your workshop.

1. Desk reviews

Desk reviews are intermediate steps before the final review. It is a great way to invite participants to look at others' creative work and provide helpful feedback, since it is often difficult for the design creator to see alternative options and enhancements. In this process, fellow participants, or just the facilitators/instructors, go from group to group, asking them explain the thought process and product. You can help them by acknowledging the strengths of the design work and then point out places where they can improve their designs to further enhance the ideas they are exploring. It is also a good time to help them find the best way to represent their ideas and the right tool to do that. For example, should they build a model of one space in their design? Would a perspective sketch be helpful?

Other queries to ask during the desk review might be:

- How is your design exploring themes of restorative justice?
- Where are the spaces for all the stakeholders you are designing for?
- What are the core values of your design and how are they being represented?
- How can you strengthen your ideas in this design?
- What is the most important feature in your project?
- Where do people enter the space and how should they feel here?

2. Final review

Guide for final reviewers

Final reviewers offer feedback later in the design process. Reviewers are often practicing architects/design professionals or experts on the project being presented, such as facility administrators or restorative justice practitioners.

The role of the reviewer is to respond to the work by providing their thoughts on what they see and reactions to what has been presented. This helps the designer understand how they can refine and improve the design. It is also intended to be a conversation amongst all parties for mutual learning and collaborative problem solving. It is also a critical learning from this toolkit. Helping participants to communicate their ideas to others in a public way is a critical skill for life and work.

While the students are presenting, reviewers can ask for clarification throughout the presentation or take notes and write down any questions they may have for later discussion. Once done, each reviewer addresses aspects of the design they find most intriguing, ask for clarification, and identify areas for improvement or elements the designer could investigate in the future. Dialogue amongst reviewers and presenters is encouraged.

Guide for presenters during the final review

Being able to present one's thoughts and ideas is an important life and work skill.

The role of the presenter is to clearly articulate and present the thinking that led to the design. To prepare, a presenter should know how long they have to speak and think through the most important points to make to the reviewers. If working in a team, each person takes a portion of the presentation so everyone shares responsibility for presenting the design. Encourage presenters to write down what they want to say and practice beforehand with each other. Each participant group should tape up their work in a way that makes it easy for them to explain their key points. Each group can get from 10 to 15 minutes to present and, while speaking, will make reference to the models, drawings and sketches they have done. Prepare presenters for the fact that reviewers are there to help and may ask clarifying questions during the presentation and after the presentation is complete. The reward and pride that comes from presenting creative work to the world and receiving positive feedback cannot be underestimated and is a powerful finale to using this curriculum and toolkit.



Sample Workshop Agendas

Sample 10-hour agenda

Session 1 – 2 ½ hours

45 minutes: Introductions

- Facilitator and participant introductions
- Opening design activity: Group collage (Tool 2, sample exercise)
- Debrief design activity
- Participant Handout – Tool 2: Collage

15 minutes: Workshop agenda

- Review agenda
- Introduce visual diaries (Tool 1)
- Participant Handout – Tool 1: Visual Diary

45 minutes: Discussion about restorative justice

- Pre-workshop reading: *Little Book of Restorative Justice for People in Prison*, Toews

30 minutes: Diagrams

- Introduce diagrams (Tool 3)
- Start to diagram (Tool 3, sample exercise)
- Participant Handout – Tool 3: Diagrams

15 minutes: Review assignments and close

- Visual diary (Tool 1, sample exercise)
- Finish or start a new diagram (Tool 3, sample exercise)
- Closing circle

Session 2 – 2 ½ hours

15 minutes: Opening circle

45 minutes: Discussion of visual diary and diagrams

- See debriefing questions in Tool 1: Visual Diary and Tool 3: Diagram

30 minutes: Small group preparation

- Form groups
- Decide what space the group will (re)design
- Discuss preliminary design issues
- Participant Handouts: Design Team Project (two handouts, Appendix 5)

45 minutes: Design tool instruction – Diagrams with moveable pieces

(Tool 3, see Make and Build) or Model Making with Paper (Tool 7)

- Introduce design tool
- Start to practice design, using space to be (re)designed
- Participant Handout – Tool 3: Diagrams or Tool 7: Model Making with Paper

15 minutes: Review assignments and close

- Visual diary (see Design Team Project participant handout, point 1)
- Reading assignment: *Restorative Justice Design: Developing New Typologies for Social Change*, Van Buren
- Closing circle

Session 3 – 2 ½ hours**15 minutes: Opening circle****30 minutes: Discussion of reading****1 ½ hours: Design work in teams**

- Share visual diary entries as part of work
- Design!

15 minutes: Review assignments and close

- Visual diary (see Design Team Project participant handout, point 1)
- Review presentation instructions
- Closing circle

Session 4 – 2 ½ hours**30 minutes: Opening**

- Circle
- Review presentation instructions
- Introduce reviewers
- Pin up designs

1 ¼ hours: Presentations**45 minutes: Closing**

- Celebrate presentations
- Certificates
- Closing circle

Sample 17-hour agenda**Session 1 – 3 ½ hours****45 minutes: Introductions**

- Facilitator and participant introductions
- Opening design activity: Group collage (Tool 2, sample exercise)
- Debrief design activity
- Participant Handout – Tool 2: Collage

15 minutes: Workshop agenda

- Review agenda
- Introduce visual diaries (Tool 1)

30 minutes: Designing for Love

- Tool 1: Visual Diary - Complete sample exercise
- Debrief sample exercise
- Participant Handout – Tool 1: Visual Diary

1 hour: Discussion about restorative justice

- Pre-workshop reading: *Little Book of Restorative Justice for People in Prison*, Toews

45 minutes: Diagrams

- Tool 3: Diagrams – Introduce and complete sample exercise
- Debrief sample exercise
- Participant Handout – Tool 3: Diagrams

15 minutes: Review assignments and close

- Visual diary (Tool 1, prompt 2)
- Diagram (Tool 3, prompt 1)
- Closing circle

Session 2 – 3 ½ hours**15 minutes: Opening circle****45 minutes: Discussion of visual diary and diagrams**

- See debriefing questions in Tool 1: Visual Diary and Tool 3: Diagram

45 minutes: Small group preparation

- Form groups
- Decide what space the group will (re)design
- Discuss preliminary design issues
- Participant Handouts: Design Team Project (two handouts, Appendix 5)

45 hour: Diagrams with moveable pieces

- Tool 3: Diagram – instruction (see Make and Build section)
- Work in design teams formed earlier to begin creating diagram for chosen site

45 minutes: Interviews

- Tool 10: Interviews – Instruction and sample exercise
- Participant handout: Tool 10 (2 handouts)

15 minutes: Review assignments and close

- Visual diary (see Design Team Project participant handout, point 1)
- Complete interviews
- Reading assignment: *Restorative Justice Design: Developing New Typologies for Social Change*, Van Buren
- Closing circle

Session 3 – 3 ½ hours**15 minutes: Opening circle****30 minutes: Discussion of visual diary entries and interview results****45 minutes: Discussion of reading and implications for design concepts****45 minutes: Perspective/Montage (Tool 4) and Model Making with Paper (Tool 7)**

- Design each design team in half - half of each group receives instruction on perspective/montage and the other half receives instruction on model making with paper
- Participants handouts: Tool 4: Perspective/Montage and Tool 7: Model Making with Paper

1 hour: Design work in teams

- Share visual diary entries and interview results
- Share what learned in previous instruction session
- Plan of design concept
- Design work

15 minutes: Review assignments and close

- Visual diary (see Design Team Project participant handout, point 1)
- Closing circle

Session 4 – 3 ½ hours**15 minutes: Opening circle****3 hours: Design work****15 minutes: Review assignments and close**

- Visual diary (see Design Team Project participant handout, point 1)
- Review presentation instructions (see Participant Handouts: Design Team Project)
- Closing circle

Session 5 – 3 ½ hours**30 minutes: Opening**

- Circle
- Review presentation instructions
- Introduce reviewers
- Pin up designs

2 hours: Presentations**1 hour: Closing**

- Celebrate presentations
- Certificates
- Closing circle

*Re-envision justice
architecture...*

*Join us in designing
place that restore
and transform*



www.designingjustice.com